



 **POLARIS**<sup>®</sup>

MY18 Sptsmn/ACE APP ACC US  
  
 USA | 9930374 MY18 Sptsmn/ACE APP US • 9930374

FIND EVERYTHING YOU'RE LOOKING FOR AT [POLARIS.COM/SHOP](http://POLARIS.COM/SHOP)

UNLESS NOTED, TRADEMARKS ARE THE PROPERTY OF POLARIS INDUSTRIES INC. 509 is a registered trademark of 509, Inc. Amara is a registered trademark of Kuraray Co. Ltd. of Japan. AP-360 is a registered trademark of TK. BatteryMinder is a registered trademark of VDC Electronics Inc. Bluetooth is a registered trademark of Bluetooth Sig. Inc. Break-Up is a registered trademark of Haas Outdoors, Inc. Camoplast is a registered trademark of Camoplast Solideal Inc. CREE is a registered trademark of Cree, Inc. FOX is a registered trademark of Fox Factory Inc. GoPro is a registered trademark of GoPro Inc. Hamelin is a registered trademark of Johnson Controls Technology Inc. Kevlar is a registered trademark of E.I. du Pont de Nemours & Company. Kolpin is a registered trademark of Kolpin Outdoors, Inc. Maxxis is a registered trademark of Cheng Shin Rubber Ind. Co. Ltd. MB Quart is a registered trademark of Maxxonics USA Inc. Moose Utility Division is a registered trademark of LeMans Corporation. Mossy Oak is a registered trademark of Haas Outdoors, Inc. MTX is a registered trademark of Mitek Corporation. OGI is a registered trademark of Ogi International, Inc. Rigid is a registered trademark of Rigid Hitch, Inc. Velcro is a registered trademark of Velcro Industries B.V. Ltd Co, Netherlands. Walker Evans is a registered trademark of Walker Evans Enterprises Corp. WARN is the registered mark of Warn Industries, Inc. Yeti is a registered trademark of Yeti Coolers, LLC. YKK is a registered trademark of YKK Corporation. Pro Armor is a registered trademark of Polaris Industries Inc. Prices and availability are subject to change at any moment. Copyright © 2017 Polaris Industries. All rights reserved.

US VERSION



 **POLARIS**<sup>®</sup>  
**SPORTSMAN**<sup>®</sup>

**2018** ACCESSORIES + APPAREL



 **POLARIS**<sup>®</sup>  
**ACE**<sup>®</sup>



# GET ON SOME OFF-ROAD

The Polaris® Sportsman® is engineered to be the hardest-working, smoothest-riding ATV available.



## POLARIS SPORTSMAN®

### RECREATION/UTILITY



**SPORTSMAN® 450 H.O. (EPS)**  
33HP



**SPORTSMAN® 570 SP**  
44HP



**SPORTSMAN® 570 (EPS) UTILITY ED.**  
44HP



**SPORTSMAN® 450 H.O. UTILITY ED.**  
33HP



**SPORTSMAN® 570 (EPS)**  
44HP



**SPORTSMAN® 850**  
78HP



**SPORTSMAN® 850 SP**  
78HP



**SPORTSMAN XP® 1000**  
90HP

### SPORT/UTILITY



**SPORTSMAN® X2 570 EPS**  
44HP



**SPORTSMAN® TOURING 570 (EPS)**  
44HP



**SPORTSMAN® TOURING 570 SP**  
44HP



**SPORTSMAN® TOURING 850 SP**  
78HP



**SPORTSMAN® TOURING XP 1000**  
88HP



**SPORTSMAN® BIG BOSS® 6X6 570 EPS**  
44HP

### 2-UP & UTILITY

### SPORT & MUD



**SCRAMBLER® 850**  
78HP



**SCRAMBLER® XP 1000**  
89HP



**SPORTSMAN® 850 HIGH LIFTER EDITION**  
78HP



**SPORTSMAN XP® 1000 HIGH LIFTER EDITION**  
85HP

## POLARIS ACE®



# SINGLE-SEAT FREEDOM.

For a new kind of off-road adventure, Polaris ACE® combines the performance of Polaris® with the confidence of a centered driving experience.



**POLARIS ACE® 500**  
32HP



**POLARIS ACE® 570 EPS**  
45HP



**POLARIS ACE® 900 XC**  
78HP



**POLARIS ACE® 150 EFI**   
15HP

### SPORTSMAN®

POLARIS ENGINEERED ACCESSORIES™	02	450/570	10
TRAIL	04	XP TOURING	12
BUMPERS	06	HUNT	14
XP 1000	08	BIG BOSS®/SCRAMBLER®	16

### COMMON ITEMS

POLARIS NORTHSTAR® COOLERS	18
WINCH/PLOW	20
WHEELS/TIRES	26

### COMMON ITEMS

TRACKS/TECHNOLOGY	32
LIGHTING	34
AUDIO	36
ESSENTIALS	38

OIL/LUBRICANTS	48
GARAGE	50
APPAREL	58

### POLARIS ACE®

POLARIS ACE® 900	40
POLARIS ACE® 570/150	42
BUMPERS & GUARDS	44
CAB SYSTEM	46



# DESIGNED FOR YOU ENGINEERED TOUGH

**POLARIS**<sup>®</sup>  
ENGINEERED PARTS  
ACCESSORIES & APPAREL

Ensuring Polaris Engineered Accessories™ fit and work in sync with your machine is the most critical phase of testing and validation. With seamless integration, you can trust that any Polaris® accessory you install will enhance your interaction beyond your expectations.

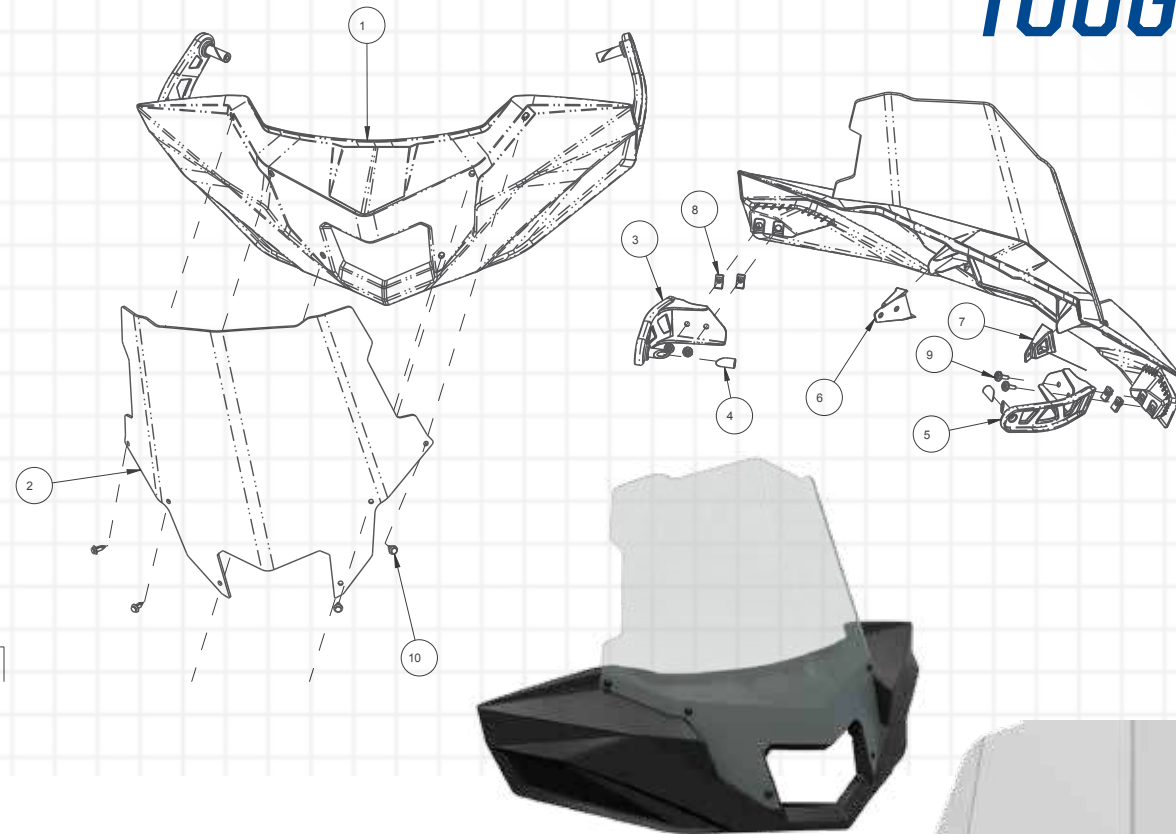

## DESIGNED

Only Polaris Engineered Accessories™ are conceived, designed and fabricated in lockstep with the Polaris SPORTSMAN® development process. As the vehicle progresses from concept to production, so do the accessories. This ensures perfect fit and optimal performance.

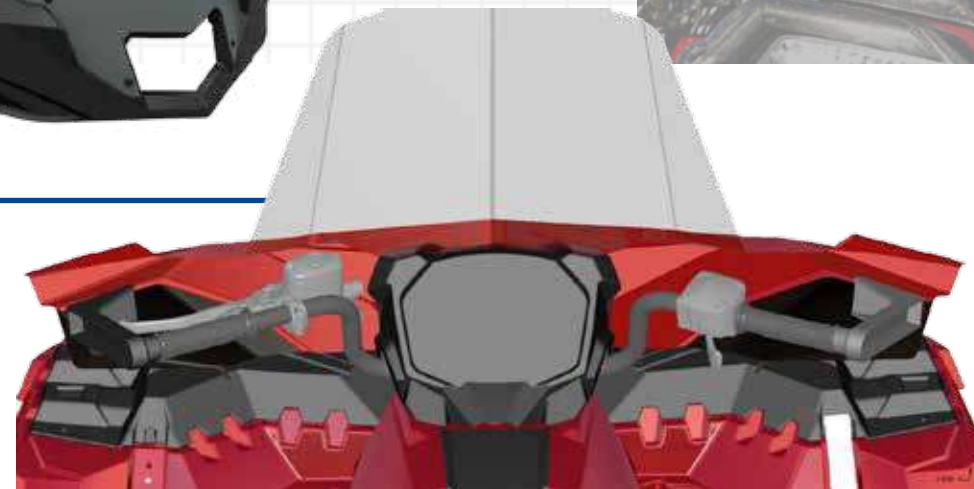

## TESTED

The Polaris® testing process is rigorous and unforgiving. We put both vehicle and accessory through extreme use conditions both in the lab and in the field - in all environments, and in locations spanning the continent. If it doesn't pass our standards, it's not ready for your Polaris® vehicle. This means only the best make it to production.

## TRUSTED

Developing the best, most premium accessories in the industry is our passion. Only Polaris® can combine decades of industry-leading experience, innovation, and off-road expertise. You can have confidence in your Polaris Engineered Accessories™, because we know the lifestyle and live it everyday.

## POLARIS® PARTNERS WITH THE BEST

We choose our partners carefully, selecting only the best in off-road. Every accessory is rigorously tested and validated at Polaris® standards, to ensure seamless integration and performance.



**KOLPIN**<sup>®</sup>  
OUTDOORS  
HUNTING ACCESSORIES p.14



**PRO ARMOR**<sup>®</sup>  
WHEELS & TIRES p.26  
LIGHTING SOLUTIONS p.34

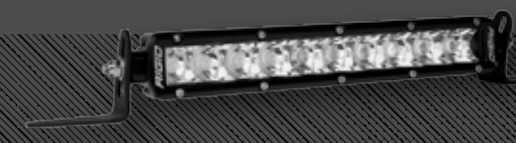

**RIGID**<sup>®</sup>  
LIGHTING SOLUTIONS p.34



**MBQUART**<sup>®</sup>  
AUDIO COMPONENTS p.36



# THE ULTIMATE ATV



POLARIS® SPORTSMAN XP® 1000  
HAVASU RED PEARL

No matter where the trail takes you, you can rely on your legendary Sportsman XP® 1000, 850, & 850 SP and the new line of Polaris Engineered Ultimate Series Accessories™ to help you own your day off-road. Add everything from brushguards and lighting to windshields and storage racks to ensure you're equipped for the ultimate off-road ride.



A. WINDSHIELD FAIRING • 2882512

WINDSHIELD (MID) • 2882151

B. RACK EXTENDER 4"

(FRONT & REAR) • 2882022 & 2882023

C. FRONT BUMPER • 2882020

D. RIGID® 10" SR-SERIES COMBO LIGHT BAR • 2883123

LED LIGHT BAR HARNESS • 2882320

E. POLARIS® PRO HD 3500 LB WINCH • 2880435

F. BODY ARMOR • 2882090

G. POLARIS NORTHSTAR® COOLER - 30 QT • 2881315

H. POLARIS® RATCHET TIE-DOWN STRAPS BLACK • 2859047-02

I. PRO ARMOR® WHEEL & TIRE SET:

SIXR MATTE BLACK & ATTACK • 2881360

J. LOCK & RIDE® REAR CARGO BOX • 2882882

K. REAR BUMPER • 2882583

L. REAR CARGO HOLD BAG • 2882303



# ALL-TERRAIN SAFEGUARDS

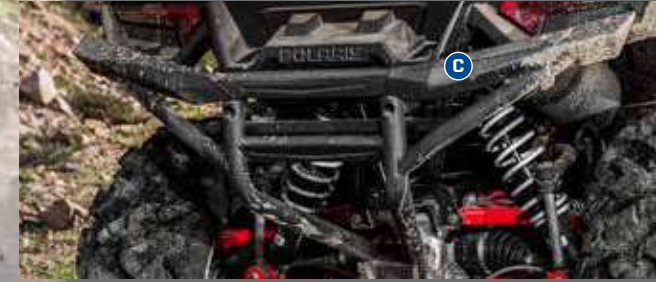

- A SPORTSMAN® ULTIMATE SERIES -FRONT BUMPER**
  - Quick installation to the integrated mounting tubes on the vehicle using wedge-style expansion anchor mounts
  - Attach the all-new Body Armor to the front bumper to provide the ultimate protection package for the front fenders

» 2882020 • \$249<sup>99</sup>  
XP 1000 '17-18, 850/850 SP '17-18
- B SPORTSMAN® ULTIMATE SERIES -BODY ARMOR**
  - Securely mounts to new Sportsman XP® Front Bumper (2882020)

» 2882090 • \$299<sup>99</sup>  
XP 1000 '17-18, 850/850 SP '17-18
- C SPORTSMAN® ULTIMATE SERIES -REAR BUMPER**
  - Adds heavy-duty rear protection and a custom look

» 2882583 • \$199<sup>99</sup>  
XP 1000 '17-18, 850/850 SP '17-18

**SPORTSMAN® 570 / 450 H.O. BRUSHGUARD** TOP SELLER



• Durable black powdercoating for long-lasting, scratch-resistant finish

**FRONT BRUSHGUARD**

» 2879714 • \$219<sup>99</sup>  
X2 570 '15-18, TOURING 570 SP '15-18, TOURING 570 '14-18, ETX '15-16, 570 SP '15-18, 570 '14-18, 570 6X6 '17-18, 450 H.O. '16-18

**REAR BRUSHGUARD**

» 2879715 • \$169<sup>99</sup>  
TOURING 570 SP '15-18, TOURING 570 '14-18, ETX '15-16, 570 SP '15-18, 570 '14-18, 450 H.O. '16-18

**SPORTSMAN XP® BRUSHGUARD**



• Integrated mounting location for easy installation and accessory lighting

**FRONT BRUSHGUARD**

» 2878709 • \$219<sup>99</sup>  
XP 1000 '15-16, X2 850 '11-12, X2 550 '10-14, TOURING XP 1000 '15-18, TOURING 850 SP '15-18, TOURING 850 '10-14, TOURING 550 '10-14, 850/XP1000 '16-17, 850/850 SP '09-16, 550 '09-14

**REAR BRUSHGUARD**

» 2878710 • \$169<sup>99</sup>  
XP 1000 '15-16, 850/XP 1000 '16-17, 850/850 SP '09-16, 550 '09-14

**SPORTSMAN® DELUXE BRUSHGUARD**



**FRONT BRUSHGUARD**

» 2878669 • \$199<sup>99</sup>  
TOURING 500 '13, 800 '12-14, 800 6X6 '12-14, 500 '12-14, 500 H.O. '12-13, 400 H.O. '12-14

**REAR BRUSHGUARD**

» 2878670 • \$139<sup>99</sup>  
800 '12-14, 500 '12-14, 500 H.O. '12-13, 400 H.O. '12-14



## EXPANSION WEDGE ANCHORS

Ultimate Series front and rear bumpers attach quickly and easily thanks to expansion wedge anchors. Since they fit into the integrated mounting points found on your Sportsman XP® 1000 or 850, there is no need to drill holes into the vehicle's frame.



**FARM & RANCH FRONT BUMPER** NEW

• Includes front receiver for additional functionality

» 2882301 • \$299<sup>99</sup>  
ETX '15, 570 '14-17, 450 H.O. '16-18



**SPORTSMAN® TOURING REAR BRUSHGUARD**

• Adds heavy-duty rear protection and a custom look

» 2878324 • \$149<sup>99</sup>  
TOURING XP 1000 '15-18, TOURING 850 SP '15-18, TOURING 850 '10-14, TOURING 550 '10-14



**SPORTSMAN® X2® REAR BUMPER**

• Distinctive off-road styling for customization

• Provides additional protection from trail hazards

• Designed specifically for the Sportsman X2®

» 2877686 • \$119<sup>99</sup>  
X2 850 '11-12, X2 550 '10-14, 570SP X2 -'17, 850SP X2 -'17



# SPORTSMAN® ULTIMATE SERIES

The ultimate rec / utility ATVs deserve the ultimate line of accessories. Equip your Sportsman XP® 1000 or 850 with our line of Ultimate Accessories and enjoy all-day comfort. Add a windshield to cut the bitterly cold wind, keep your hands warm with a simple-to-install hand warmer kit, prevent items from sliding off your racks with an extension kit, or simply add more storage.

## SPORTSMAN® ULTIMATE SERIES WINDSHIELDS

### WINDSHIELD FAIRING

- Customizable system based on your style and protection needs
- All-new fairing is the base for the best wind protection system to date

» 2882512 • \$149<sup>99</sup>  
XP 1000 '17-18, 850/850 SP '17-18



### WINDSHIELD FAIRING BAG

» 2882454 • \$39<sup>99</sup>  
XP 1000 '17-18, 850/850 SP '17-18



EASY TO CHANGE WINDSHIELDS  
WITH 6-DART INSTALL

Our fairing system allows for changing out the windshield quickly and easily. Simply remove the six dart-type fasteners and swap out the windshield.

### TALL VIEW

» 2882152 • \$99<sup>99</sup>  
XP 1000 '17-18, 850/850 SP '17-18

### TALL VIEW HARD COAT

» 2881161 • \$199<sup>99</sup>  
XP 1000 '17-18, 850/850 SP '17-18

### MID VIEW

» 2882151 • \$89<sup>99</sup>  
XP 1000 '17-18, 850/850 SP '17-18

### LOW VIEW

» 2882150 • \$79<sup>99</sup>  
XP 1000 '17-18, 850/850 SP '17-18

### HARD COAT

Give your impact-resistant poly windshield extra defense. Hard coat is 30x more scratch-resistant, meaning you'll be able to handle whatever gets thrown at you.

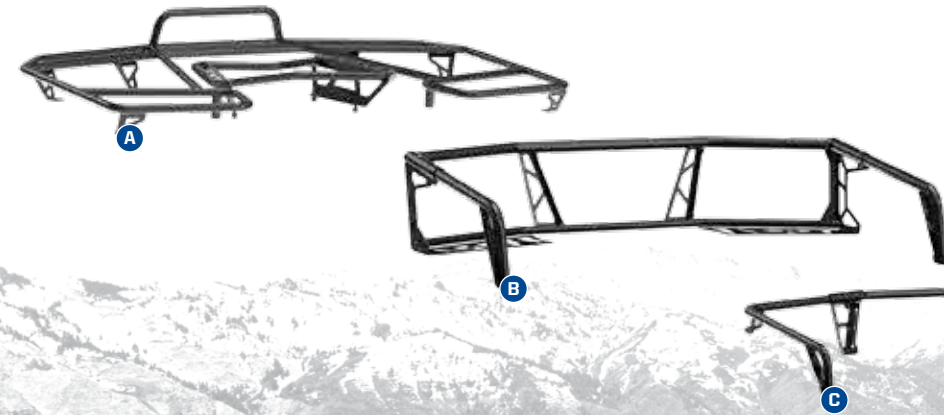
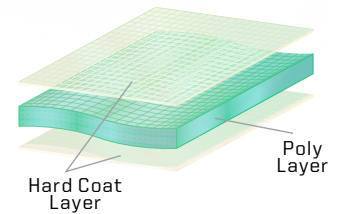

A	B	C	D
<b>SPORTSMAN® STEEL RACK</b> <i>NEW</i>	<b>ULTIMATE SERIES RACK EXTENDER 7"</b>	<b>ULTIMATE SERIES RACK EXTENDER 4"</b>	<b>MOVEABLE TIE-DOWN POINTS</b>
REAR	REAR	REAR	FRONT / REAR
» 2883258 • \$199 <sup>99</sup> XP 1000 '17-18, 850/850 SP '17-18	» 2882025 • \$149 <sup>99</sup> XP 1000 '17-18, 850/850 SP '17-18 Does not fit with (2882882)	» 2882023 • \$99 <sup>99</sup> XP 1000 '17-18, 850/850 SP '17-18 Fits with Rear Cargo Box (2882882)	» 2882270 • \$49 <sup>99</sup> <b>(SOLD IN PAIRS)</b> XP 1000 '17-18, 850/850 SP '17-18



E	F	G
<b>ULTIMATE SERIES RACK EXTENDER 4"</b>	<b>ULTIMATE SERIES RACK EXTENDER 7"</b>	<b>SPORTSMAN® STEEL RACK</b> <i>NEW</i>
FRONT	FRONT	FRONT
» 2882022 • \$99 <sup>99</sup> XP 1000 '17-18, 850/850 SP '17-18	» 2882024 • \$149 <sup>99</sup> XP 1000 '17-18, 850/850 SP '17-18	» 2883257 • \$149 <sup>99</sup> XP 1000 '17, 850/850 SP '17-18



### LOCK & RIDE SPORTSMAN® ULTIMATE SERIES REAR CARGO BOX

- Increase your ATV storage with an extra 25 gallons of capacity
- Store two full-size helmets.

» 2882882 • \$299<sup>99</sup>  
XP 1000 '17-18, 850/850 SP '17-18, ETX '15, 570 SP '15-18, 570 '14-18, 450 H.O. '16-18



### SPORTSMAN® ULTIMATE SERIES REAR CARGO HOLD BAG

- Upgrade your stock rear storage component with this removable, divided storage bag

» 2882303 • \$59<sup>99</sup>  
XP 1000 '17-18, 850/850 SP '17-18



### THROTTLE/THUMB WARMERS

» 2877364 • \$44<sup>99</sup>  
ALL SPORTSMAN® MODELS



### HANDLEBAR HAND WARMERS

» 2877363 • \$54<sup>99</sup>  
ALL SPORTSMAN® MODELS



### ULTIMATE SERIES - READYPACK

- Keep your trail essentials at the ready with this easy-to-access, weather-resistant storage compartment

» 2882271 • \$59<sup>99</sup>  
XP 1000 '17-18, 850/850 SP '17-18



### LOCK & RIDE FRONT CARGO BOX

- Replaces stock rack, adds convenient storage location

» 2877951 • \$169<sup>99</sup>  
XP 1000 '15-16, TOURING XP 1000 '15-18, TOURING 850 SP '15-18, TOURING 850 '10-14, TOURING 550 '10-14, 850/850 SP '09-16, 550 '09-14



# SPORTSMAN® 450/570 SERIES

Hardworking and smooth riding combine to give you the legendary Polaris Sportsman® ATV. On your land, on the farm, or at the job site, Sportsman® has accessories to make your day more comfortable and convenient.

## SPORTSMAN® LOCK & RIDE® POLY WINDSHIELDS



### LOCK & RIDE SPORTSMAN® WINDSHIELDS

SIZE	COLOR	PART #	PRICE	SIZE	COLOR	PART #	PRICE
TALL 19.25" (48.9 CM)	CLEAR	2878389	• \$129 <sup>99</sup>	TALL 19.25" (48.9 CM)	CLEAR	2880539-409	• \$149 <sup>99</sup>
MID 15.5" (39.4 CM)	BLACK	2878388-070	• \$149 <sup>99</sup>	MID 15.5" (39.4 CM)	BLACK	2880540-070	• \$159 <sup>99</sup>
MID 15.5" (39.4 CM)	SMOKE	2878388	• \$129 <sup>99</sup>	MID 15.5" (39.4 CM)	SMOKE	2880540-412	• \$139 <sup>99</sup>
LOW 9.5" (24.1 CM)	BLACK	2878387	• \$84 <sup>99</sup>	LOW 9.5" (24.1 CM)	BLACK	2880541-070	• \$119 <sup>99</sup>

X2 570 '15-17, TOURING 570 '14-17, TOURING 500 '13, ETX '15, 800 6X6 '12-14, 800 '12-14, 570 '14-17, 500 H.O. '12-13, 500 '12-14, 450 H.O. '16-17, 400 H.O. '12-14

XP 1000 '15-16, TOURING XP 1000 '15-18, TOURING 850 SP '15-18, TOURING 570 SP '15-17, 850/850 SP '09-16, 570 SP '15-18, 570 '18, 570 6X6 '17-18, 450 H.O. '18

### HANDGUARDS

#### COLORS

BLACK	2876846	• \$29 <sup>99</sup>
BRIGHT WHITE	2876883	• \$29 <sup>99</sup>
INDY RED	2876845	• \$29 <sup>99</sup>

ALL SPORTSMAN® MODELS

### HANDGUARD MOUNT

• This handguard mount is required when installing Polaris® Handguards

» 2879380 • \$29<sup>99</sup>  
ALL SPORTSMAN®



### SPORTSMAN® 570/450 H.O. STEEL RACK

#### REAR

» 2882322 • \$199<sup>99</sup>  
ETX '15, 570 SP '15-17, 570 '14-17, 450 H.O. '16-18

### SPORTSMAN® 570/450 H.O. RACK EXTENDERS TOP SELLER

#### REAR

» 2879717 • \$99<sup>99</sup>  
ETX '15, 570 SP '15-18, 570 '14-18, 450 H.O. '16-18

### SPORTSMAN® BACKREST

#### REAR

» 2879887 • \$199<sup>99</sup>  
ETX '15, 570 SP '15-17, 570 '14-17, 450 H.O. '16-18  
Does not fit with K-CARGO BOX, REAR, LOCK&RIDE® (2875176)



### SPORTSMAN® 570/450 H.O. RACK EXTENDERS TOP SELLER

#### FRONT

» 2879716 • \$99<sup>99</sup>  
X2 570 '15-18, TOURING 570 SP '15-18, TOURING 570 '14-18, ETX '15, 570 SP '15-18, 570 '14-18, 570 6X6 '17-18, 450 H.O. '16-18

### SPORTSMAN® 570/450 H.O. STEEL RACK

#### FRONT

» 2882321 • \$129<sup>99</sup>  
X2 570 '15-18, TOURING 570 '14-18, 570 SP '15-18, 570 '14-18, 570 6X6 '17-18, ETX '15, 450 H.O. '16-18



### LOCK & RIDE XL STORAGE BOX

» 2881128-070 • \$169<sup>99</sup>  
XP 1000 '15-18, X2 570 '15-18, ETX '15, 850/XP 1000 '16-17, 850/850 SP '09-18, 800 '12-14, 570 SP '15-18, 570 '14-18, 570 6X6 '17-18, 550 '09-14, 500 '12-14, 500 H.O. '12-13, 450 H.O. '16-18, 400 H.O. '12-14

While the XL Storage Box box comes with two dividers and can be used as is, it really serves its purpose when combined with up to three of our XL Bags. The bags are designed to serve a specific need and can be easily removed for portability.

### LOCK & RIDE XL STORAGE BOX MOUNT

• Includes mount kit and tie down straps  
• Tie-down straps are required for added cargo security

» 2881331 • \$29<sup>99</sup>  
XP 1000 '15-18, ETX '15-16, 850/XP 1000 '16-17, 850/850 SP '09-18, 800 '12-14, 570 SP '15-18, 570 '14-18, 550 '09-14, 500 '12-14, 500 H.O. '12-13, 450 H.O. '16-18, 400 H.O. '12-14



### A. XL SOFT SIDE COOLER

» 2881428 • \$39<sup>99</sup>



### B. XL TRAIL BAG

» 2881130 • \$39<sup>99</sup>



### C. XL TOOL BAG

» 2881129 • \$39<sup>99</sup>



### XL POLARIS PURSUIT CAMO RANGE BAG

» 2881131 • \$79<sup>99</sup>

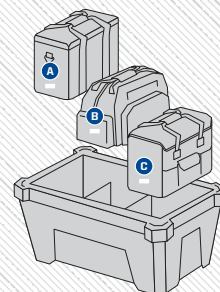

### LOCK & RIDE SPORTSMAN® ULTIMATE SERIES REAR CARGO BOX

• Increase your ATV storage with an extra 25 gallons of capacity  
• Store two full-size helmets.

» 2882882 • \$299<sup>99</sup>

XP 1000 '17-18, 850/850 SP '17-18, ETX '15, 570 SP '15-18, 570 '14-18, 450 H.O. '16-18



### FENDER BAG

• Easy to access while seated  
• Pockets hold water bottles

» 2876604 • \$49<sup>99</sup>

ALL SPORTSMAN® MODELS  
Bag does not work with the Front Storage Box (2877951)



### HANDLEBAR HAND WARMERS

» 2877363 • \$54<sup>99</sup>

ALL SPORTSMAN® MODELS



### THROTTLE/THUMB WARMERS

» 2877364 • \$44<sup>99</sup>

ALL SPORTSMAN® MODELS



# SPORTSMAN XP® TOURING

When you are enjoying the trails on your Sportsman® Touring XP 1000, you need a line of accessories that won't get in the way of your passenger's experience. All Sportsman XP® Touring accessories are designed specifically to enhance the 2-up experience.

## SPORTSMAN® LOCK & RIDE® POLY WINDSHIELDS



Mid 15.5" (39.4 cm) Black



Low 9.5" (24.1 cm) Black

Poly windshields are flexible, **IMPACT RESISTANT**, and provide long-term value over the life of your machine.

### LOCK & RIDE SPORTSMAN® WINDSHIELDS

COLOR	SIZE	SKU	PRICE
CLEAR	TALL 19.25" (48.9 CM)	2880539-409	» \$149 <sup>99</sup>
BLACK	MID 15.5" (39.4 CM)	2880540-070	» \$159 <sup>99</sup>
SMOKE	MID 15.5" (39.4 CM)	2880540-412	» \$139 <sup>99</sup>
BLACK	LOW 9.5" (24.1 CM)	2880541-070	» \$119 <sup>99</sup>

XP 1000 '15-16, TOURING XP 1000 '15-18, TOURING 850 SP '15-18, TOURING 570 SP '15-17, 850/850 SP '09-16, 570 SP '15-18, 570 '18, 570 6X6 '17-18, 450 H.O. '18



### A XP RACK EXTENDER

#### FRONT

» 2879890 • \$99<sup>99</sup>

XP 1000 '15-16, X2 850 '11-12, X2 550 '10-14, TOURING XP 1000 '15-18, TOURING 850 SP '15-18, TOURING 850 '10-14, TOURING 550 '10-14, 850/850 SP '09-16, 550 '09-14

### B SPORTSMAN® RACK EXTENDER

#### FRONT

» 2878671 • \$89<sup>99</sup>

TOURING 500 '13, 800 6X6 '12-14, 800 '12-14, 500 H.O. '12-13, 500 '12-14, 400 H.O. '12-14



### SEMI-RIGID TOURING CARGO BAG

- Large-capacity, heavy-duty vinyl bag
- Three zippered openings, removable dividers
- Attaches to rack with Velcro® straps

» 2877220 • \$149<sup>99</sup>

TOURING 570 '14-18, TOURING 500 '13, 500 H.O. '12



### LOCK & RIDE REAR STORAGE BOXES

- Made of heavy-duty polyethylene (Sold in pairs)

» 2878000 • \$189<sup>99</sup>

TOURING XP 1000 '15-18, TOURING 850 SP '15-18, TOURING 850 '10-14, TOURING 550 '10-14

Slight interference with Sportsman® Touring 550/850 '11-14 passenger handles



### LOCK & RIDE FRONT CARGO BOX

- Replaces stock rack, adds convenient storage location

» 2877951 • \$169<sup>99</sup>

XP 1000 '15-16, TOURING XP 1000 '15-18, TOURING 850 SP '15-18, TOURING 850 '10-14, TOURING 550 '10-14, 850/850 SP '09-16, 550 '09-14

The Front Rack Extender cannot be installed at the same time as the storage box



### FENDER BAG

- Perfect place to store gear and snacks
- Easy to access while seated

» 2876604 • \$49<sup>99</sup>

ALL SPORTSMAN® MODELS

Bag does not work with the Front Storage Box (2877951)

## LEGACY ACCESSORIES

### SPORTSMAN® RACK EXTENDER

#### REAR

» 2879891 • \$99<sup>99</sup>

XP 1000 '15-16, 850/XP 1000 HL '16-18, 850/850 SP '09-16, 550 '09-14

### SPORTSMAN® RACK EXTENDER

#### REAR

» 2878672 • \$99<sup>99</sup>

800 '12-14, 500 H.O. '12-13, 500 '12-14, 400 H.O. '12-14

### SPORTSMAN® RACK EXTENDER

#### FRONT

» 2878671 • \$89<sup>99</sup>

TOURING 500 '13, 800 6X6 '12-14, 800 '13-14, 500 H.O. '13, 500 '13-14, 400 H.O. '13-14

### SPORTSMAN XP® RACK EXTENDER

#### FRONT

» 2879890 • \$99<sup>99</sup>

XP 1000 '15-16, X2 850 '11-12, X2 550 '10-14, TOURING XP 1000 '15-18, TOURING 850 SP '15-18, TOURING 850 '10-14, TOURING 550 '10-14, 850/850 SP '09-16, 550 '09-14

Does not fit vehicles with Front Cargo Box (2877951)

### LOCK & RIDE BACKREST

- Fully adjustable for optimal comfort

» 2876616 • \$199<sup>99</sup>

XP 1000 '15-16, 850/850 SP '09-16, 550 '09-14

Does not fit with Lock & Ride® Cargo Box (2876601) installed

### HANDLEBAR HAND WARMERS

- Keep both hands warm while riding
- Complete kit includes all wiring

» 2877363 • \$54<sup>99</sup>

ALL SPORTSMAN® MODELS

### THROTTLE/THUMB WARMERS

- Keeps throttle thumb warm
- Complete kit includes all wiring

» 2877364 • \$44<sup>99</sup>

ALL SPORTSMAN® MODELS

### HANDLEBAR-MOUNTED MIRROR

- For added safety on or off the trail

» 2877222 • \$34<sup>99</sup>

ALL SPORTSMAN® MODELS



# BE THE APEX PREDATOR

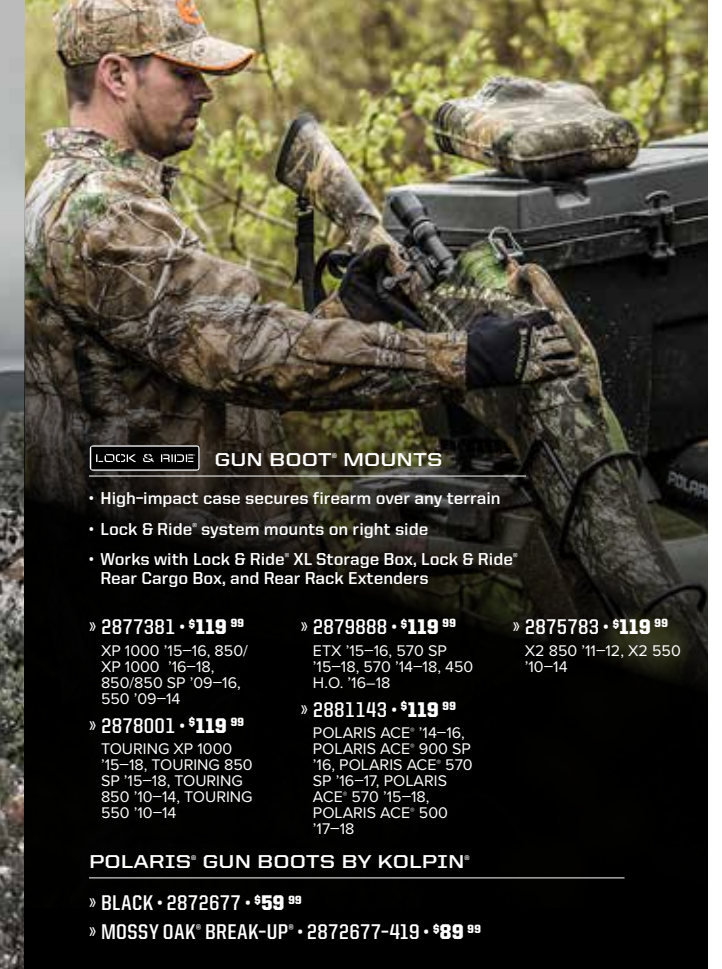

## LOCK & RIDE GUN BOOT MOUNTS

- High-impact case secures firearm over any terrain
- Lock & Ride® system mounts on right side
- Works with Lock & Ride® XL Storage Box, Lock & Ride® Rear Cargo Box, and Rear Rack Extenders

» 2877381 • \$119 <sup>99</sup> XP 1000 '15-16, 850/ XP 1000 '16-18, 850/850 SP '09-16, 550 '09-14	» 2879888 • \$119 <sup>99</sup> ETX '15-16, 570 SP '15-18, 570 '14-18, 450 H.O. '16-18	» 2875783 • \$119 <sup>99</sup> X2 850 '11-12, X2 550 '10-14
» 2878001 • \$119 <sup>99</sup> TOURING XP 1000 '15-18, TOURING 850 SP '15-18, TOURING 850 '10-14, TOURING 550 '10-14	» 2881143 • \$119 <sup>99</sup> POLARIS ACE® '14-16, POLARIS ACE® 900 SP '16, POLARIS ACE® 570 SP '16-17, POLARIS ACE® 570 '15-18, POLARIS ACE® 500 '17-18	

## POLARIS® GUN BOOTS BY KOLPIN®

- » BLACK • 2872677 • \$59<sup>99</sup>
- » MOSSY OAK® BREAK-UP® • 2872677-419 • \$89<sup>99</sup>



## KOLPIN STRONGHOLD® SYSTEM

Polaris® is proud to partner with Kolpin® Outdoors, an industry leader in off-road accessories and the premier name in gun boots and mounts. If you need to secure a firearm, fishing rod, or ice auger while riding, simply attach the auto-latch mount and choose your case.

KOLPIN STRONGHOLD® PRODUCTS SECURELY PROTECT THE ESSENTIALS WHEN ON THE TRAIL.



Check out p.10 for the LOCK & RIDE® XL STORAGE BOX and more storage options for your Sportsman XP® 1000 or 850



## XL POLARIS PURSUIT® CAMO RANGE BAG

» 2881131 • \$79<sup>99</sup>  
ALL SPORTSMAN®

## RATCHETING RHINO GRIP® BY KOLPIN®

- Requires minimal rack space and attaches using Lock & Ride® technology

» 2881157 • \$59<sup>99</sup>  
ALL SPORTSMAN®



## RHINO GRIP® XL BY KOLPIN®

» 2881513 • \$39<sup>99</sup>  
ALL SPORTSMAN®



## RUBBER STRAPS BY KOLPIN®

» 2881621 • \$4<sup>99</sup>  
ALL SPORTSMAN®



### AUTO-LATCH MOUNT **NEW**

- Precision angle adjustable for a custom fit
- Provides a quick and secure attachment point

» 2882300 • \$69<sup>99</sup>  
ETX '15, 570 SP '15-18, 570 '14-18, 450 H.O. '16-18

» 2882272 • \$69<sup>99</sup>  
XP 1000 '17-18, 850/850 SP '17-18

### GUN BOOT® XL TRANSPORT

» 2882430 • \$99<sup>99</sup>  
Requires Auto-Latch Mount (2882272 or 2882300)

### GUN BOOT® L

» 2882426 • \$59<sup>99</sup>  
Requires Auto-Latch Mount (2882272 or 2882300)

### PISTOL BOOT

» 2882429 • \$49<sup>99</sup>  
Requires Auto-Latch Mount (2882272 or 2882300)

### ICE ROD BOOT

» 2882428 • \$99<sup>99</sup>  
Requires Auto-Latch Mount (2882272 or 2882300)

### ICE AUGER BOOT

» 2882427 • \$79<sup>99</sup>  
Requires Auto-Latch Mount (2882272 or 2882300)



# SPORTSMAN® BIG BOSS® 6X6



## POLARIS® SCRAMBLER®

Power, performance, and handling distinguish this unique ATV from the competition. Make sure to make it your own with accessories designed specifically for this hardworking sport performer.



### A OGIO® SCRAMBLER® BAG

» 2879925 • \$169<sup>99</sup>  
SCRAMBLER® '13-18

### B LARGE REAR RACK

» 2879139 • \$159<sup>99</sup>  
SCRAMBLER® '13-18

Not compatible with Ogio® Scrambler® Bag (2879925)

### C REAR BASH GUARD

» 2879138 • \$139<sup>99</sup>  
SCRAMBLER® '13-18

### D HANDGUARDS

» 2876846 • BLACK • \$29<sup>99</sup>  
SCRAMBLER® '13-18

### E POLARIS® HD 2500 LB WINCH

» 2880433 • \$379<sup>99</sup>  
SCRAMBLER® '13-18

### POLARIS® HD 3500 LB WINCH

» 2880435 (NOT SHOWN) • \$449<sup>99</sup>

### WINCH WIRING HARNESS

» 2879919 • \$24<sup>99</sup>  
SCRAMBLER® XP 1000 '14-17,  
SCRAMBLER® 850 '13-17,  
Required to install Polaris® HD Winches

### F HANDLEBAR HEADLIGHT

» 2879245 • \$349<sup>99</sup>  
SCRAMBLER® '13-18

### G BRUSHGUARD

» 2879136 • \$199<sup>99</sup>  
SCRAMBLER® '13-18

### H PRO ARMOR® WHEEL & TIRE SET: REBLR & ATTACK

» 2881381 • \$1,249<sup>99</sup>

### I 10MM X 1.25 HEX LUG NUTS (16 PACK)

» 2877384 • \$29<sup>99</sup>

### I FORGED BEADLOCK RINGS

» 14" VOODOO BLUE • 1522244-619  
\$79<sup>99</sup>

Sold individually. See other forged beadlock rings on pg. 30.

## SPORTSMAN® BIG BOSS® 6X6 ACCESSORIES

### A LOCK & RIDE YUKON ADVENTURE RACK

• Adds increased storage volume by allowing you to increase storage height securely

» 2882084 • \$299<sup>99</sup>  
570 6X6 '17-18

### LOCK & RIDE CARGO BOX ADAPTOR KIT

• Required to add the Sportsman® Cargo Box (2875176) onto the '17-18 Sportsman® Big Boss® 6x6

» 2882302 • \$99<sup>99</sup>  
570 6X6 '17-18  
Requires (2875176)

### LOCK & RIDE GUN BOOT® MOUNT ADAPTOR KIT

• Utilize this adapter kit to add the Lock & Ride® Gun Boot® Mount (2879888) onto the '17-18 Sportsman® Big Boss® 6x6

» 2882257 • \$34<sup>99</sup>  
570 6X6 '17-18

### PROSPECTOR PRO® TRACK SYSTEM

• Delivers true 3-season performance with more flotation and less maintenance

• Rubber pivot system allows rear axles to move independently for maximum traction

• Includes Track Mount & Track Kit

» 2882169 • \$5,999<sup>99</sup>  
570 6X6 '17-18



### GLACIER PRO HD PLOW SYSTEM

Page 24 for Plow Systems



### PROSPECTOR PRO® TRACKS

Page 32



### PRO ARMOR® WHEELS & TIRES

Page 26



# KEEP IT ICE COLD



## POLARIS NORTHSTAR® COOLER ACCESSORIES



### WIRE BASKET

- » 60 QUART • 2882185 • **[SHOW]** • \$29<sup>99</sup>
- » 30 QUART • 2882438 • \$24<sup>99</sup>



### DIVIDERS

- » 60 QUART • 2882184 • \$39<sup>99</sup>  
COMES WITH ONE DIVIDER
- » 30 QUART • 2882186 • \$19<sup>99</sup>  
COMES WITH ONE DIVIDER

Divider doubles as a cutting board



### SEAT CUSHION

- » 60 QUART • 2882179 • \$79<sup>99</sup>
- » 30 QUART • 2882507 • \$59<sup>99</sup>

### COOLER WHEELS

- » 2882180 • \$89<sup>99</sup>  
60 QUART ONLY



### BOTTLE OPENER

- » 2882183 • \$9<sup>99</sup>  
ALL COOLERS

### LOCK & RIDE QUICKSTRAP

- » 2882187 • \$39<sup>99</sup>  
ALL COOLERS, RANGER® AND POLARIS GENERAL CARGO BOXES



### TIE-DOWN STRAPS

- » 2859047-01 • RED • \$19<sup>99</sup>  
ALL COOLERS
- » 2859047-02 • BLACK • \$19<sup>99</sup>  
ALL COOLERS



HOLDS ICE  
**30+**  
HOURS  
LONGER  
THAN YETI®\*

\*YETI is a registered trademark of YETI COOLERS, LLC

## GRIZZLY TESTED. POLARIS® APPROVED.

This cooler is IGBC-approved, meaning it withstands the power expended by a typical grizzly bear if it was trying to get inside. Seriously, there are experts who know what a grizzly is capable of doing, and they certify that the Polaris Northstar® Cooler can take it.



### POLARIS NORTHSTAR® COOLER

- 105 QUART - Fall Availability
- » **NEW** GRAPHITE • 2883426 • \$379<sup>99</sup>
- » DESERT • 2883392 • \$379<sup>99</sup>
- 60 QUART
- » **NEW** GRAPHITE • 2883425 • \$299<sup>99</sup>
- » DESERT • 2881259 • \$299<sup>99</sup>
- 30 QUART
- » **NEW** GRAPHITE • 2883424 • \$229<sup>99</sup>
- » DESERT • 2881315 • \$229<sup>99</sup>
- 20 QUART SOFTSIDE
- » **NEW** GRAPHITE • 2883390 • \$149<sup>99</sup>
- TUMBLERS **NEW** NOT SHOWN
- » 30 OZ • 2883394 • \$24<sup>99</sup>
- » 20 OZ • 2883393 • \$19<sup>99</sup>

30, 60, 105  
QUART FEATURES

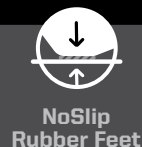



**SUPERIOR**

# INTEGRATION

Right from the factory, your vehicle is built to make essential accessories like winches and plows quick and simple to install and use regularly. Mounting brackets are designed into the chassis and wiring is routed securely and properly. Perfect fit, perfect integration.

**GLACIER<sup>PRO</sup> HD**  
PLOW SYSTEM

**DEPENDABLE. TOUGH.  
BUILT FOR THE OFF-ROAD.**



✓ Tested **1,200+** pulls at max load, it works when you need it to



✓ Built to withstand **-20° F** temperatures



✓ Sealed motor & heavy duty gears **OPERATE FULLY SUBMERGED UNDERWATER**



✓ **MILITARY** tested & approved

**PRE-WIRED CHASSIS**

Handlebar controls and wiring are installed at the factory. Mount the winch, connect the wires and trust that everything is routed safely, securely, and properly.

**NO NEED TO CUT PANELS**

**FULLY INTEGRATED MOUNT & WIRING**

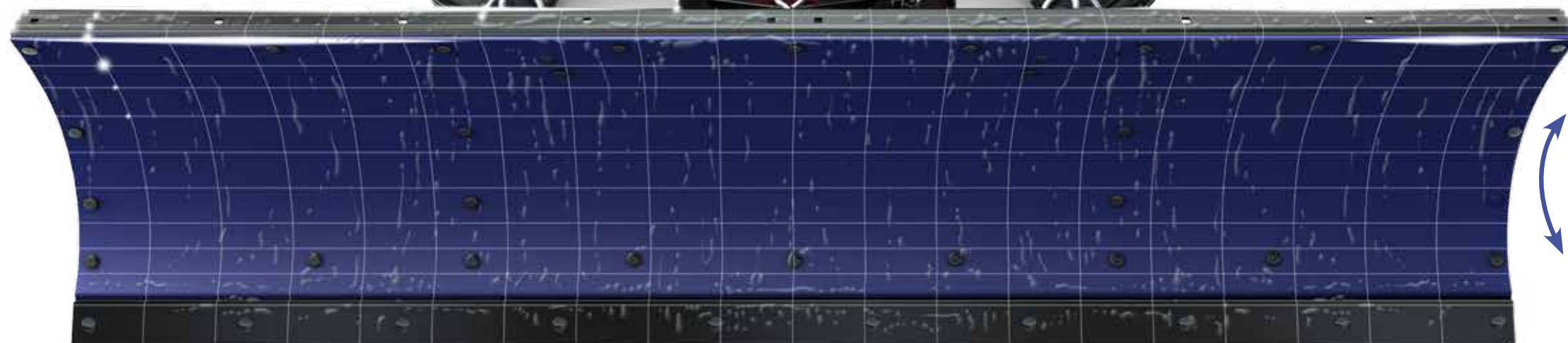
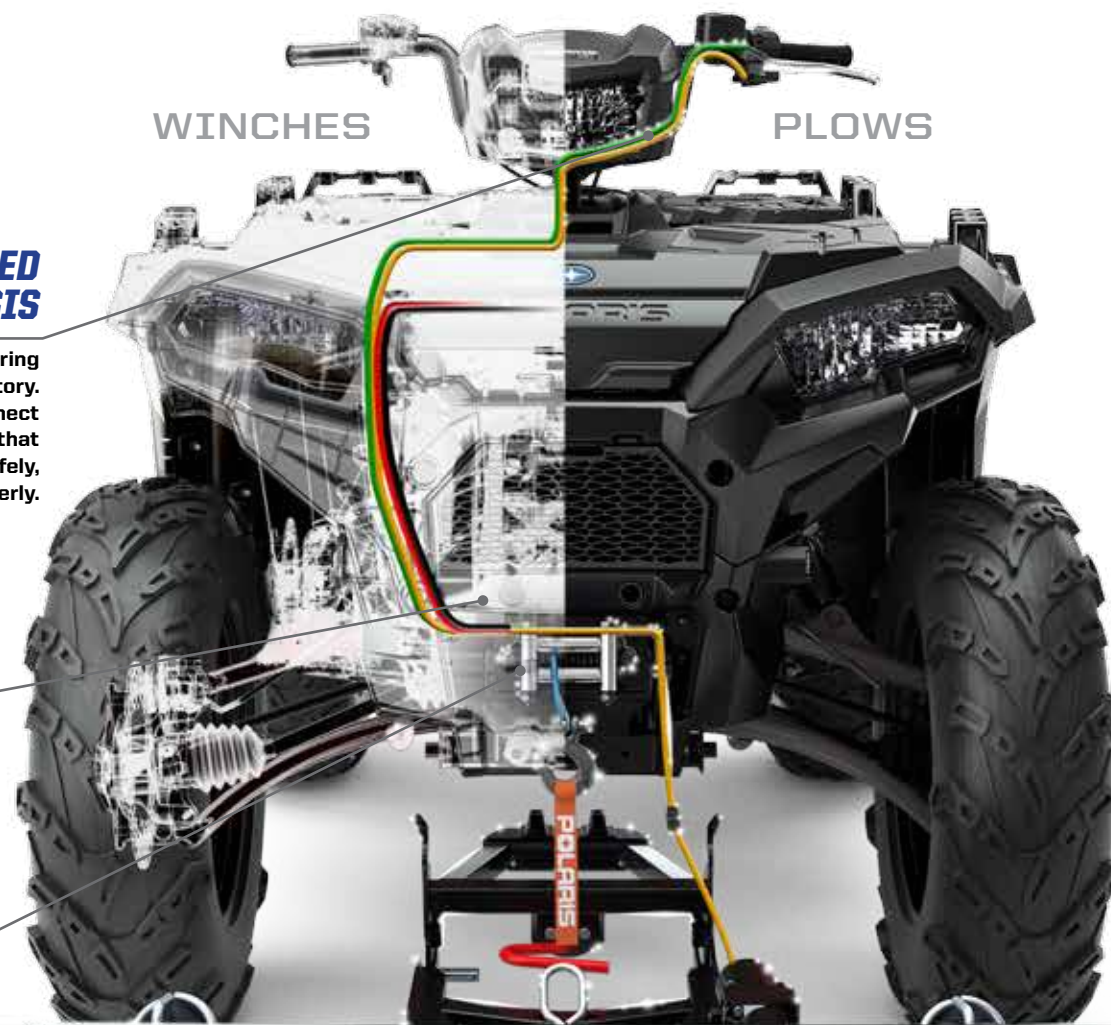

**GLACIER<sup>®</sup> vs. COMPETITION**



WARN<sup>®</sup>



MOOSE UTILITY DIVISION<sup>®</sup>



SUPERATV

- ✓ To install the plow, simply lift the mount lock handle and pull forward.
- ✓ No loss of factory ground clearance when not plowing.
- ✓ Don't have to crawl under the machine to release the plow blade from the vehicle.
- ✓ No trimming of vehicle plastic or fascia required to mount plow or winch.

**25°**

LEFT AND RIGHT



ANGLE YOUR BLADE RIGHT FROM YOUR SEAT



# CLEAR THE WAY

**DEPENDABLE. TOUGH. BUILT FOR THE OFF-ROAD.**

- ✔ Tested **1,200+** pulls at max load, so it works when you need it to
- ✔ Built to withstand **-20° F** temperatures
- ✔ Sealed motor & heavy duty gears **OPERATE FULLY SUBMERGED UNDERWATER**
- ✔ **MILITARY** tested & approved
- ✔ **FULLY INTEGRATED** mount & wiring

**HD HEAVY DUTY SERIES**

**3500 LB. WINCH**

50' OF 4.8MM PREMIUM HIGH-STRENGTH SYNTHETIC ROPE

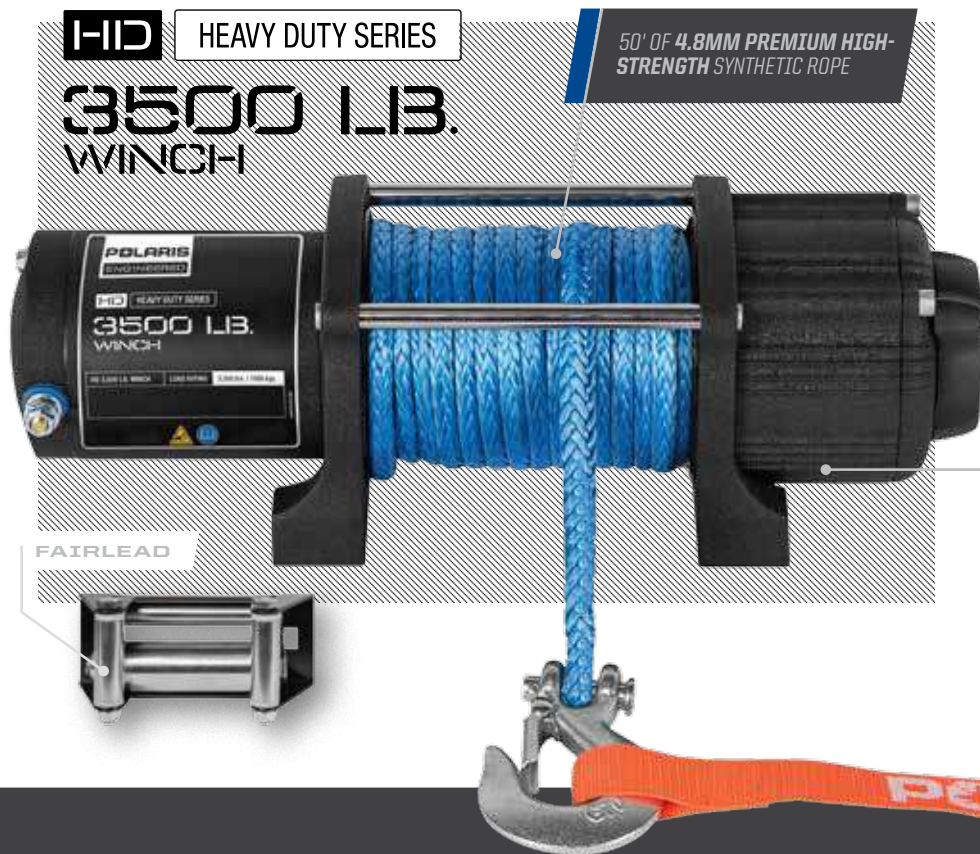

FAIRLEAD

**DURABLE, CORROSION-RESISTANT FINISH**

**POLARIS® HD 3500 LB WINCH**

- 1-year warranty
- » 2880434 • **\$449<sup>99</sup>**  
X2 570 '15-18, TOURING 570 SP '15-18, TOURING 570 '14-18, ETX '15-16, 570 SP '15-18, 570 '14-18, 570 6X6 '17-18, 450 H.O. '16-18
- » 2880435 • **\$449<sup>99</sup>** **TOP SELLER**  
XP 1000 '15-18, TOURING XP 1000 '15-18, TOURING 850 SP '15-18, TOURING 850 '12-14, TOURING 550 '12-14, SCRAMBLER '13-18, 850/XP1000 HL '16-18, 850/850 SP '12-18, 550 '12-14
- » 2882106 • **\$449<sup>99</sup>**  
POLARIS ACE® '14-16, POLARIS ACE® 900 XC '17-18, POLARIS ACE® 900 SP '16, POLARIS ACE® 570 SP '16-17, POLARIS ACE® 570 '15-18, POLARIS ACE® 500 '17-18

**HD HEAVY DUTY SERIES**

**2500 LB. WINCH**

50' OF 4.8MM HIGH-STRENGTH STEEL CABLE



FAIRLEAD

**POLARIS® HD 2500 LB WINCH**

- 1-year warranty
- » 2880432 • **\$379<sup>99</sup>** **TOP SELLER**  
X2 570 '15-18, TOURING 570 SP '15-18, TOURING 570 '14-18, ETX '15-16, 570 SP '15-18, 570 '14-18, 570 6X6 '17-18, 450 H.O. '16-18
- » 2880433 • **\$379<sup>99</sup>**  
XP 1000 '15-18, TOURING XP 1000 '15-18, TOURING 850 SP '15-18, TOURING 850 '12-14, TOURING 550 '12-14, SCRAMBLER '13-18, 850/XP1000 HIGHLIFTER '16-18, 850/850 SP '12-18, 550 '12-14
- » 2882105 • **\$379<sup>99</sup>**  
POLARIS ACE® '14-16, POLARIS ACE® 900 XC '17-18, POLARIS ACE® 900 SP '16, POLARIS ACE® 570 SP '16-17, POLARIS ACE® 570 '15-18, POLARIS ACE® 500 '17-18

**RETRO FIT WIRE HARNESS**

- » 4015094 • **\$19<sup>99</sup>**  
LEGACY INSTALL

**WINCH ACCESSORIES**

**POWER CONTROLLER**

- Allows the rider to control plow angle and blade height from inside the cab

- » 2880836 • **\$49<sup>99</sup>**  
POLARIS ACE® 900 SP '16, POLARIS ACE® 570 SP '16-17, POLARIS ACE® 570 '15-18, POLARIS ACE® 500 '17-18, POLARIS ACE® '14-16



**POLARIS® WIRELESS WINCH REMOTE**

- » 2879316 • **\$129<sup>99</sup>**  
ALL SPORTSMAN® & POLARIS ACE® MODELS



**UPGRADE YOUR HD WINCH WITH THESE ACCESSORIES**



**POLARIS® AUTO-STOP WINCH UPGRADE KIT**

- Requires use of synthetic cable rope (not included)

- » 2881693 • **\$99<sup>99</sup>**  
ALL SPORTSMAN® & POLARIS ACE® MODELS



**SYNTHETIC WINCH ROPE**

- Includes pre-woven hook

- » 2878888 • **\$74<sup>99</sup>**  
2500 LB & 3500 LB WINCHES

**WHY UPGRADE TO SYNTHETIC?**

- Easier to work with - flexible and smooth texture
- More durable for plow usage
- Doesn't kink or bind like steel cable
- Lighter weight - even floats on water



# GLACIER®

## PLOW SYSTEM

When you have the power of a Glacier® Pro Plow System on your machine, you can truly take command of clearing snow and moving whatever you need to. Find the blade that fits your needs and you'll make quick work of even the heaviest jobs.



### THE POLARIS ENGINEERED™ ADVANTAGE

#### INSTALLATION

30 seconds: Drive up, clip in, lock down, and go – the integrated Polaris Engineered™ Glacier® Plow System simplifies plowing.

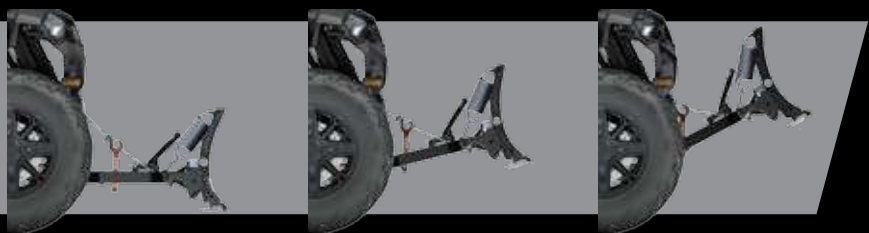

#### CONVENIENCE

Lift and angle adjustments can be made from the driver's seat.

ANGLE YOUR BLADE RIGHT FROM YOUR SEAT WITH THE GLACIER® PRO PLOW HYDRAULIC ANGLE SYSTEM



#### ROBUST FRAME

A plow system is only as strong as its frame, and Polaris Engineered™ plow frames have a wide frame to withstand the rigors of heavy plowing.



#### DURABILITY

Available in strong stamped steel or corrosion-resistant poly materials, Polaris Engineered™ plow blades cover a large surface area for quick snow removal.

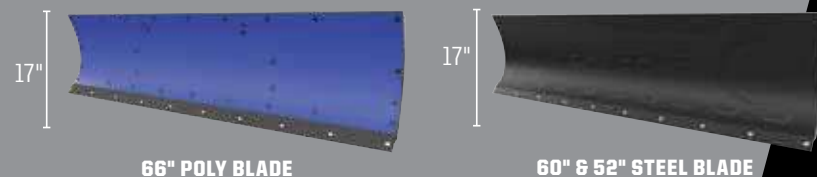

66" POLY BLADE

60" & 52" STEEL BLADE

# BUILD YOUR PERFECT PLOW SYSTEM

GLACIER® PLOW SYSTEM



ANGLE YOUR BLADE RIGHT FROM YOUR SEAT WITH THE GLACIER® PRO PLOW HYDRAULIC ANGLE SYSTEM

- 1 SELECT A MOUNT**
- 2 SELECT A FRAME & ANGLE OPTIONS**
- 3 CONFIGURE PLOW**
- 4 SELECT A BLADE**

#### GLACIER® INTEGRATED PLOW MOUNT

• Fits all current Glacier® Pro Plow System components

- » 2881423 • \$169<sup>99</sup>  
XP 1000 '15-18, TOURING XP 1000 '15-18, TOURING 850 SP '15-18, SCRAMBLER '15-18, 850/XP 1000 HIGHLIFTER '16-18, 850/850 SP '15-18
- » 2881424 • \$169<sup>99</sup>  
X2 570 '15-18, TOURING 570 SP '15-18, TOURING 570 '15-18, ETX '15, 570 SP '15-18, 570 '15-18, 570 6X6 '17-18, 450 H.O. '16-18

#### PLOW MOUNT

- » 2879634 • \$199<sup>99</sup>  
POLARIS ACE® '14-16, POLARIS ACE® 570 SP '16, POLARIS ACE® 570 '15-16
- » 2882107 • \$199<sup>99</sup>  
POLARIS ACE® 900 XC '17-18, POLARIS ACE® 570 SP '17, POLARIS ACE® 570 '17-18, POLARIS ACE® 500 '17-18
- » 2879632 • \$169<sup>99</sup>  
X2 850 '11-12, X2 550 '10-14, TOURING 850 '10-14, TOURING 550 '10-14, 850/850 SP '09-14, 550 '09-14
- » 2879633 • \$169<sup>99</sup>  
TOURING 570 '14, TOURING 500 '13, 800 '12-14, 570 '14, 500 H.O. '12-13, 500 '12-14, 400 H.O. '12-14

#### GLACIER® PLOW FRAME

- » 2879630 • \$249<sup>99</sup>  
ALL SPORTSMAN® & POLARIS ACE® MODELS  
For use with Glacier® Pro Sportsman® and Polaris ACE® plow systems

#### GLACIER® PRO PLOW HYDRAULIC ANGLE SYSTEM

- Angle your plow blade with the push of a button so you can clear more snow or other material
- » 2879635 • \$549<sup>99</sup>  
Power Controller Recommended (2880836)  
For use with Glacier® Pro Sportsman® and Polaris ACE® plow systems

#### POWER CONTROLLER

- Allows the rider to control plow angle and blade height from the seat
- » 2880836 • \$49<sup>99</sup>  
ALL POLARIS ACE® MODELS

#### POLARIS® HD 3500 LB. WINCH

See page 22.

#### POLARIS® HD 2500 LB. WINCH

See page 23.

#### PLOW WINCH ROPE

- Improved durability for plow use vs. steel cable
- Thicker than standard synthetic rope
- 8' (2.4m) of 0.25" (6mm) braided rope
- » 2878483 • \$29<sup>99</sup>  
FOR USE WITH 2500 LB & 3500 LB WINCHES

#### GLACIER® PLOW BLADES

- Requires plow blade frame for mounting (sold separately)
- Includes plow blade and metal wear bar
- » 66" • POLY • 2880269 • \$399<sup>99</sup>
- » 60" • STEEL • 2879638 • \$249<sup>99</sup>
- » 52" • STEEL • 2879639 • \$209<sup>99</sup>  
FITS ALL SPORTSMAN® AND POLARIS ACE®

#### GOT TRACKS?



#### GLACIER® PRO PLOW TRACK EXTENSION

- » 2879719 • \$179<sup>99</sup>
- Plow extension for use when using the prospector pro track system and Glacier® Pro Sportsman® or Polaris ACE® plow system

FOR USE WITH GLACIER® PRO SPORTSMAN® AND POLARIS ACE® PLOW SYSTEMS

#### SELECT ACCESSORIES

##### PLOW BLADE SNOW DEFLECTOR

- » 66" • 2879866 • \$79<sup>99</sup>
- » 60" • 2871808 • \$59<sup>99</sup>

##### QUICK RELEASE SKID SHOES

- Helps prevent blade wear
- Hardened steel for industrial strength
- » 2877245 • \$19<sup>99</sup>

##### GLACIER® PRO SHEAR PIN

- » 2205063 • \$13<sup>99</sup>

##### WEAR BARS

• Protect your plow blade and minimize wear on the actual blade by installing Wear Bars

- » 66" • 2879867 • \$49<sup>99</sup>
- » 60" • 2871806 • \$39<sup>99</sup>
- » HD 66" • 2879868 • \$99<sup>99</sup>
- » 52" • 2877210 • \$34<sup>99</sup>

##### COIL SPRING SPACER

• Keep the front end of the vehicle up and improve ride quality when using a plow on strut or A-arm vehicles

- » 2872655 • \$15<sup>99</sup>

##### PLOW MARKER

• Helps driver monitor plow blade position

- Sold in pairs
- » 2872726 • \$19<sup>99</sup>

##### SHEAR PIN REPLACEMENT

• Direct replacement for a Glacier® Pro ATV Plow System Shear Pin

- » 2205063 • \$13<sup>99</sup>



# PRO ARMOR®



# TIRES

Polaris® and Pro Armor® developed a deep partnership thanks to having similar histories and passion for producing products that enhance vehicle performance. Each wheel and tire Pro Armor® designs and engineers for Polaris® off-road vehicles perform perfectly in the intended environment for its intended use. Developed, tested, and produced in partnership so you can tackle the terrain ahead.



## 10-PLY

Pro Armor® builds the toughest tires to keep you running when the terrain turns tough. A higher ply rating means added protection. Choose your tire and ply rating based on use and overall performance needs.

## DUAL COMPOUNDS

You don't ride or drive in just one type of terrain, so Pro Armor® builds certain tires with multiple wear zones. A dual-durometer design allows the tire to wear better with softer outer lugs and harder inner lugs.

## TRIPLE-BELTED SIDEWALLS

Sidewalls can be a vulnerable area of any off-road tire. Rocks jump out at your machine and tear into sidewalls. Thanks to reinforced construction in this critical area, Pro Armor® resists when others fail.

## TORTURE-TESTED TOUGH

Pro Armor® pushes beyond normal-use testing, and blows by extreme-use testing. The duty cycle developed by Pro Armor® engineers puts other tires to shame. When you mount a set of Pro Armor® tires, be assured they're ready for rugged terrain.

PRO ARMOR® ATTACK	347 LB
MAXXIS® BIGHORN 2.0	162 LB
MAXXIS® BIGHORN	150 LB

## 3,000 MILE RATED

Pile on the miles with Pro Armor® tires. Every tire is designed and constructed with longevity in mind. With ratings of 3,000 miles and beyond, you are assured long life and performance.

TIRE: **DUAL-THREAT**

WHEEL: **BUCKLE ACCENT**

### KNOW YOUR TIRES

**DIMENSIONS**  
**28" x 9" R14**  
TIRE HEIGHT | TIRE WIDTH | WHEEL DIAMETER

**TREAD DEPTH**  
A deeper tread means more grip and better performance

**WEIGHT**  
A lighter tire makes for improved vehicle performance

**PLY RATING**  
Indicates the overall load capability of the tire

**SIDEWALL BELTS**  
Sidewall belts increase your resistance to sidewall punctures

**LOAD RATING**  
Tires with higher load ratings can handle more weight

**PADDLE DEPTH**  
Increases grip and performance in the sand



# TRAIL



FRONT

REAR

## PRO ARMOR® DUAL-THREAT **NEW**

Engineered with dual-compound technology and radial construction to offer revolutionary off-road performance in all terrains. The lateral-grip compound on the outer edges of the tire has a softer durometer rubber for cornering performance and superior grip. The long-wearing compound in the middle of the tire has harder durometer rubber for increased traction during acceleration, straight line stability, and overall longer tread life.

14" 26" x 9" R14 • FRONT • 5416340 • \$159<sup>99</sup>  
26" x 11" R14 • REAR • 5416341 • \$169<sup>99</sup>

	TREAD DEPTH	WEIGHT	PLY RATING	SIDEWALL BELTS	LOAD RATING
FRONT	16mm	27 lbs	10	3	910 lbs
REAR		30 lbs			1,100 lbs



WHEEL SIZE

14"

# UTILITY



WHEEL SIZE

14" 12"



WHEEL SIZE

14" 12"



WHEEL SIZE

12"

## PRO ARMOR HARVESTER®

- All-around workhorse with tread life of 5,000 miles
- Tread pattern designed to withstand anything from the farmyard and to the pastures to the trail
- With 10-Ply, it can carry the load day in and day out

14" 27" x 10" R14 • FRONT/REAR • 5415965 • \$179<sup>99</sup>  
12" 26" x 8" R12 • FRONT • 5416396 • \$169<sup>99</sup>  
12" 26" x 10" R12 • REAR • 5415966 • \$179<sup>99</sup>

## PRO ARMOR PRESERVE™ **NEW**

- Turf-friendly for areas where low impact from tire tread is needed
- Exceptionally quiet-running tire

14" 27" x 10" R14 • FRONT/REAR • 5416348 • \$179<sup>99</sup>  
12" 26" x 8" R12 • FRONT • 5416403 • \$169<sup>99</sup>  
12" 26" x 10" R14 • REAR • 5416402 • \$179<sup>99</sup>

## PRO ARMOR XD-K

- 26" Aramid fiber-belted tire can tackle any terrain
- Unique full-face tread design
- Harder durometer lugs promotes for extended wear increasing tire life

12" 26" x 9" R12 • FRONT • 5415756 • \$194<sup>79</sup>  
12" 26" x 11" R12 • REAR • 5415757 • \$204<sup>99</sup>



FRONT / REAR

## PRO ARMOR® ATTACK

- The best all-purpose tire for all-season traction in any terrain
- Unique full-face tread design
- Harder durometer lugs promote extended wear, increasing tire life

14" 26" x 9" R14 • FRONT • 5415613 • \$139<sup>99</sup>  
26" x 11" R14 • REAR • 5415614 • \$149<sup>99</sup>

	TREAD DEPTH	WEIGHT	PLY RATING	SIDEWALL BELTS	LOAD RATING
FRONT	23mm	28 lbs	8	3	910 lbs
REAR		32 lbs			1,320 lbs



WHEEL SIZE

14"

# SNOW



FRONT / REAR

## PRO ARMOR® WHITEOUT

- Extra wide tires for flotation in snow
- Tread pattern designed for superior snow traction with limited digging

14" 27" x 14" R14 • FRONT/REAR • 5416032 • \$269<sup>99</sup>

	TREAD DEPTH	WEIGHT	PLY RATING	SIDEWALL BELTS	LOAD RATING
27" R14	16mm	27 lbs	8	3	935 lbs



WHEEL SIZE

14"

# MUD



FRONT

REAR

## PRO ARMOR® DAGGER

- From the trails to the pits, this tire gets you through it all
- Deep, self-cleaning lug and wide tire design for exceptional mud pit performance
- Rounded profile and full lug pattern for on-trail comfort

14" 27" x 9" R14 • FRONT • 5415617 • \$209<sup>99</sup>  
14" 27" x 11" R14 • REAR • 5415618 • \$219<sup>99</sup>

	TREAD DEPTH	WEIGHT	PLY RATING	SIDEWALL BELTS	LOAD RATING
FRONT	38mm	32 lbs	8	3	1,100 lbs
REAR		40 lbs			1,170 lbs



WHEEL SIZE

14"





**FORGED BEADLOCK RINGS**

- Only used on REBLR wheels. 14" beadlock rings
- Sold individually

**VooDoo Blue**  
14" • 1522244-619 • \$79<sup>99</sup>

**Machined**  
14" • 1522244-266 • \$79<sup>99</sup>

**White**  
14" • 1522244-133 • \$79<sup>99</sup>

**Tndy Red**  
14" • 1522244-293 • \$79<sup>99</sup>

**Orange Crush**  
14" • 1522244-589 • \$79<sup>99</sup>

**TIRE SEALANT**

**1 Gallon**  
2830485 • \$69<sup>99</sup>

**5 Gallon**  
2830486 • \$289<sup>99</sup>

**5 Gallon Pump**  
2830487 • \$129<sup>99</sup>

**32 oz**  
2830484 • \$19<sup>99</sup>



**A AMPLIFY**

ACCENT: FRONT 14" x 7" • 1522956-266 \$139<sup>99</sup>  
REAR 14" x 8" • 1522957-266 \$149<sup>99</sup>  
MATTE BLACK: FRONT 14" x 7" • 1522956-458 \$119<sup>99</sup>  
REAR 14" x 8" • 1522957-458 \$129<sup>99</sup>

**B BUCKLE**

ACCENT: FRONT 14" x 7" • 1522544-266 \$139<sup>99</sup>  
REAR 14" x 8" • 1522545-266 \$149<sup>99</sup>  
MATTE BLACK: FRONT 14" x 7" • 1522544-458 \$119<sup>99</sup>  
REAR 14" x 8" • 1522545-458 \$129<sup>99</sup>

**C COMBAT NEW**

(BEADLOCK RINGS INCLUDED)

ACCENT: 14" x 7" • 1523284 \$199<sup>99</sup>  
MATTE BLACK: 14" x 7" • 1523283 \$189<sup>99</sup>

**D REBLR (REQUIRES BEADLOCK RINGS)**

MATTE BLACK: FRONT 14" x 7" • 1522238-458 \$209<sup>99</sup>  
REAR 14" x 8" • 1522239-458 \$209<sup>99</sup>

**E SIXR**

MATTE BLACK: FRONT 14" x 7" • 1521507-521 \$109<sup>99</sup>  
REAR 14" x 8" • 1521508-521 \$119<sup>99</sup>  
LUSTER: FRONT 14" x 7" • 1521507-410 \$139<sup>99</sup>  
REAR 14" x 8" • 1521508-410 \$144<sup>99</sup>  
MACHINED: FRONT 14" x 7" • 1521507-266 \$109<sup>99</sup>  
REAR 14" x 8" • 1521508-266 \$119<sup>99</sup>

**F SHACKLE**

ACCENT: FRONT 14" x 7" • 1522546-266 \$139<sup>99</sup>  
REAR 14" x 8" • 1522547-266 \$139<sup>99</sup>  
MATTE BLACK: FRONT 14" x 7" • 1522546-458 \$119<sup>99</sup>  
REAR 14" x 8" • 1522547-458 \$119<sup>99</sup>

**G SPLIT**

MATTE BLACK: FRONT 14" x 6" • 1522542-458 \$119<sup>99</sup>  
REAR 14" x 8" • 1522543-458 \$129<sup>99</sup>

**H THRASHER**

MATTE BLACK: FRONT 14" x 6" • 1522241-458 \$139<sup>99</sup>  
REAR 14" x 6" • 1522242-458 \$144<sup>99</sup>

**I WHITEOUT**

MATTE BLACK: 14" x 10" • 1522958 \$169<sup>99</sup>

Replacement BEADLOCK RING 14" 1523146-458 • MATTE BLACK  
FITS COMBAT WHEEL ONLY

**14" SETS**

TIRES	ANARCHY	ATTACK	DAGGER	DUAL-THREAT 26"	PRESERVE 27"	HARVESTER 27"	WHITEOUT 27"
WHEELS							
AMPLIFY Accent	2882402 \$1,599 <sup>99</sup>	2882390 \$1,199 <sup>99</sup>	2882392 \$1,449 <sup>99</sup>	2883138 \$1,249 <sup>99</sup>	2883208 \$1,299 <sup>99</sup>	2882388 \$1,299 <sup>99</sup>	
AMPLIFY Matte Black	2882403 \$1,499 <sup>99</sup>	2882391 \$1,099 <sup>99</sup>	2882393 \$1,349 <sup>99</sup>	2883139 \$1,149 <sup>99</sup>	2883209 \$1,199 <sup>99</sup>	2882389 \$1,199 <sup>99</sup>	
BUCKLE Accent	2881341 \$1,599 <sup>99</sup>	2881335 \$1,199 <sup>99</sup>	2881337 \$1,449 <sup>99</sup>	2883140 \$1,249 <sup>99</sup>	2883203 \$1,299 <sup>99</sup>	2882383 \$1,299 <sup>99</sup>	
BUCKLE Matte Black	2881342 \$1,499 <sup>99</sup>	2881336 \$1,099 <sup>99</sup>	2881338 \$1,349 <sup>99</sup>	2883141 \$1,149 <sup>99</sup>	2883204 \$1,199 <sup>99</sup>	2882384 \$1,199 <sup>99</sup>	
COMBAT Accent *BEADLOCKS PRE-MOUNTED				2883217 \$1,549 <sup>99</sup>			
COMBAT Matte Black *BEADLOCKS PRE-MOUNTED				2883216 \$1,449 <sup>99</sup>			
REBLR Matte Black *BEADLOCKS SOLD SEPARATELY		2881381 \$1,249 <sup>99</sup>	2881383 \$1,499 <sup>99</sup>				
SHACKLE Accent	2881353 \$1,599 <sup>99</sup>	2881347 \$1,199 <sup>99</sup>	2881349 \$1,449 <sup>99</sup>	2883142 \$1,249 <sup>99</sup>	2883205 \$1,299 <sup>99</sup>	2882385 \$1,299 <sup>99</sup>	
SHACKLE Matte Black	2881354 \$1,499 <sup>99</sup>	2881348 \$1,099 <sup>99</sup>	2881350 \$1,349 <sup>99</sup>	2883143 \$1,149 <sup>99</sup>	2883206 \$1,199 <sup>99</sup>	2882386 \$1,199 <sup>99</sup>	
SIXR Luster		2881359 \$1,199 <sup>99</sup>	2881362 \$1,449 <sup>99</sup>				
SIXR Matte Black	2881369 \$1,499 <sup>99</sup>	2881360 \$1,099 <sup>99</sup>	2881363 \$1,349 <sup>99</sup>	2883144 \$1,149 <sup>99</sup>	2883207 \$1,199 <sup>99</sup>	2882387 \$1,199 <sup>99</sup>	
SPLIT Matte Black		2881404 \$1,099 <sup>99</sup>	2881405 \$1,349 <sup>99</sup>	2883145 \$1,149 <sup>99</sup>			
THRASHER Matte Black	2881446 \$1,499 <sup>99</sup>	2881378 \$1,099 <sup>99</sup>	2881380 \$1,349 <sup>99</sup>				
WHITEOUT R14 Matte Black							2882382 \$1,799 <sup>99</sup>

**LUGS**



**10MM X 1.25 HEX LUG NUTS**

- » 2877385 • 4 HEX LUG NUTS • \$11<sup>99</sup>
- » 2877384 • 16 HEX LUG NUTS • \$29<sup>99</sup> Sportsman™ XP

**3/8" - 24 HEX LUG NUTS**

- » 2876754 • 4 HEX LUG NUTS • \$11<sup>99</sup>
- » 2877409 • 16 HEX LUG NUTS • \$29<sup>99</sup> Polaris ACE™, SPORTSMAN™ 450/570

**REPLACEMENT CAPS**



**POLARIS™ CAPS**

- » 1521509-410 • LUSTER • \$9<sup>99</sup>
- » 1521509-521 • MATTE BLACK \$9<sup>99</sup> AMPLIFY, BUCKLE, COMBAT, REBLR, SHACKLE, SIXR, SPLIT, WHITEOUT
- » 1522243-410 • LUSTER • \$19<sup>99</sup>
- » 1522243-458 • MATTE BLACK \$19<sup>99</sup> THRASHER



**PRO ARMOR™ CAPS**

- » 5453209-410 • LUSTER • \$9<sup>99</sup>
- » 5453209-458 • MATTE BLACK • \$9<sup>99</sup> AMPLIFY, BUCKLE, COMBAT, REBLR, SHACKLE, SIXR, SPLIT, WHITEOUT
- » 1523015-410 • LUSTER • \$9<sup>99</sup>
- » 1523015-458 • MATTE BLACK \$9<sup>99</sup> THRASHER



# ALL-TERRAIN TRACTION

It's tough to make Sportsman® and Polaris ACE® even more versatile than they already are. But with a set of Prospector Pro® Tracks, you'll do just that. Tread through deep snow without concern.

Polaris®-specific gearing provides 1:1 ratio to:

- Minimize track slip, providing better climbing ability and improved traction in deep snow
- Improve top speed over prior models by approximately 5%
- Reduce operating RPM for a quieter ride
- Improve driveline durability, which allows vehicle to run at a lower RPM, decreasing engine wear

Polaris® Exclusive optimized hub geometry that minimizes feedback and eases steering effort

Flexible lug design provides the highest level of deep snow performance by lifting up in deep snow as opposed to digging down

New front dual stabilizer for improved stability

Lightweight design provides for better flotation, eases steering effort, and provides better vehicle control



**PROSPECTOR PRO**  
TRACK SYSTEM



# POLARIS® INTERACTIVE DIGITAL DISPLAY 2.0



1. Speedometer
2. Real-Time Clock
3. Compass
4. Tachometer
5. Coolant Temperature
6. Gear Position
7. Odometer Trip Meter
8. Fuel Level Indicator
9. 4x4 Indicator

## STANDARD FEATURES

- Control of Bluetooth® audio media streaming with track and artist display
- Exporting capabilities for created tracks and waypoints from the display to USB drive
- Course-up arrow option with rotating background map now available
- Distance to a selected waypoint shown on the map screen
- Automatic day/night brightness change based on time of day and day of year
- New riding screen with increased visibility to important diagnostics, gear indicator enlarges on gear change
- High resolution, 4.3" full color LCD display
- Bluetooth® connectivity allows you to pair your smart phone and check missed calls, text message, battery life and signal strength
- Diagnostics screen displays vehicle fault codes (NEW: Voltage and engine temp faults will pop up and turn red at critical levels)
- GPS connectivity offers exact location information including elevation, latitude/longitude, and compass bearings

» 2881554 • \$799<sup>99</sup>  
POLARIS ACE®, SPORTSMAN XP®, SPORTSMAN® SP  
Must purchase Sportsman® Install Kit (2880536)

## POLARIS® INTERACTIVE DIGITAL DISPLAY INSTALL KIT

• Includes all installation hardware and harnesses

- » 2880536 • \$149<sup>99</sup>  
XP 1000 '15-16, TOURING XP 1000 '15-18, TOURING 850 SP '15-18, TOURING 570 SP '15-18, 850/850 SP '15-16, 570 SP '15-18, 570 6X6 '17-18, 450 H.O. '18, 570 '18
- » 2880537 • \$69<sup>99</sup>  
POLARIS ACE® 900 XC '17-18, POLARIS ACE® 900 SP '16, POLARIS ACE® 570 SP '16-17, POLARIS ACE® 570 '15-18, POLARIS ACE® 500 '17-18, POLARIS ACE® '14-16
- » 2882275 • \$149<sup>99</sup>  
XP 1000 '17-18, 850/850 SP '17-18



GPS connectivity offers exact location information, including elevation, latitude/longitude, and compass bearings



Bluetooth® functionality allows you to see your missed calls and text messages on the display



TPS, RPM, and ground speed playback for up to 90 seconds to easily monitor your vehicle's performance

## 1 SELECT A MOUNT

### PROSPECTOR PRO® MOUNT

- Dual bogie wheels manage weight properly & deliver a great ride & outstanding traction in snow

- » 2879457 • \$399<sup>99</sup>  
X2 850 '11-12, X2 550 '10-14, TOURING XP 1000 '17-18, TOURING 850/850 SP '10-18, TOURING 550 '10-14, SCRAMBLER '13-18, 850/850 SP '10-18, 550 '10-14, XP 1000 '15-16
- » 2879497 • \$399<sup>99</sup>  
X2 570 '15-18, TOURING 570 '14-18, ETX '15, 800 '12-14, 570 '14-18, 500 H.O. '12-13, 500 '12-14, 450 H.O. '16-18, 400 H.O. '13-14

- High Clearance Track Mount Kit
- Track sold separately

- » 2879751 • \$399<sup>99</sup>  
POLARIS ACE® 570 '15, POLARIS ACE® '14-15,
- » 2883019 • \$399<sup>99</sup>  
POLARIS ACE® 570 '16-17, POLARIS ACE® 500 '17, POLARIS ACE® '16

## 2 SELECT A KIT

### PROSPECTOR PRO® TRACKS

- Polaris® track systems deliver the utmost in performance and productivity, with absolutely no compromise of vehicle cargo capacity or pulling power.

- » 2879720 • \$3,799<sup>99</sup>  
XP 1000 '15-16, X2 850 '11-12, X2 550 '10-14, TOURING 850 '10-14, TOURING 550 '10-14, 850/850 SP '09-15, 850 MY16-18 (NON-EPS), 550 '09-14
- » 2881003 • \$3,799<sup>99</sup>  
XP 1000 '15-16, TOURING XP 1000 '15-18, TOURING 850 SP '15-18, SCRAMBLER '15-18, 850/850 SP '15-18 (EPS)
- » 2881025 • \$3,799<sup>99</sup>  
X2 570 (EPS) '15-18, TOURING 570 SP '15-18, 570 SP '15-18, 570 '16-18 (EPS)
- » 2880020 • \$3,799<sup>99</sup>  
X2 570 '17-18, TOURING 570 '14-18, TOURING 500 '13, ETX '15, POLARIS ACE® 570 '15-16, POLARIS ACE® '14-16, 800 '12-14, 570 '14-18, 500 H.O. '12-13, 500 '12-14, 450 H.O. '16-18, 400 H.O. '12-14

- They deliver the best in performance, reliability, durability and value in every season.

### PROSPECTOR PRO® TRACK SYSTEM (6X6)

- Includes Track Mount & Track Kit

- » 2882169 • \$5,999<sup>99</sup>  
570 6X6 '17-18

### QUICKTAP BATTERY POSTS

- Easy-to-access terminal posts give you quick access to the battery power
- Ideal for charging your battery, powering a temporary accessory, or when you need to offer an unexpected jump-start
- Connection posts feature covers to protect terminals when not in use

- » 2882110 • \$49<sup>99</sup>  
X2 570 '15-18, TOURING 570 '14-18, 570 SP '15-18, 570 '14-18, 570 6X6 '17-18





INTRODUCING

# RIGID®

## ADVANCED TECH

Rigid® lights are driven by Aluminum PCB Smart Boards™ with copper thermal conductive pads, gold-plated electrical contacts, 6063-T5 aircraft aluminum extruded housings treated with Alodine® corrosion preventive, and Tiger Drylac® UV protection polyester powder coating.

## EXCLUSIVE OPTICS

RIGID® hand-selects the brightest high-tech LEDs from the best manufacturers. The LEDs shine through patented optics that maximize total light output and efficiency. RIGID® lights feature impact-resistant polycarbonate lenses for a 100% water/dustproof seal.

# PRO ARMOR®



## RUGGED STYLING DURABLE CONSTRUCTION

Pro Armor® lights are designed to be big and beefy with an aggressive style all their own. Housed in IP67 marine-grade rated UV Polyester powder-coated with precision-cast end panels and oversized, extruded aluminum heat sinks to keep the temperature down.

## MASSIVELY BRIGHT

Counting up to 66 3-5 watt CREE® LEDs pushing over 11,000 lumens, Pro Armor® lights are some of the brightest in the industry. All that power is directed through heat-dissipating aluminum printed circuit boards for streamlined heat management.

**RIGID® LIMITED LIFETIME WARRANTY\*** BREAK YOUR LIGHT AND RIGID® WILL REPLACE OR REPAIR IT FOR LIFE

## 8 BEAM PATTERNS

Select from 15 to 90 degrees—the pattern changes when and how you want it.

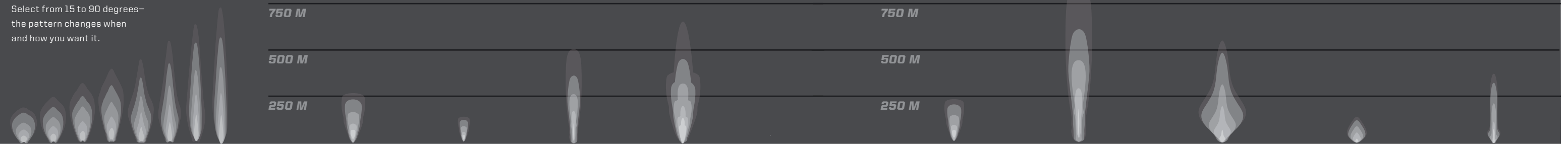

### NEW RIGID® ADAPT 10" LED

8 beam patterns that can adjust with changing conditions

LUMENS: 7,360

» 2883125  
Fall Availability



MATCH YOUR STYLE

Choose from any color in the spectrum to reflect your style or current mood.



CHANGE FROM THE DASH

A backlit, molded dash controller allows you to control the beam pattern and color.

### NEW RIGID® SR-SERIES PRO DRIVING LED

LUMENS: 4,752

» 2883128 • \$349<sup>99</sup>

Comes in a pair

### NEW RIGID® SR-SERIES PRO FLOOD LED

LUMENS: 3,168

» 2883126 • \$174<sup>99</sup>

Comes in a pair

### NEW RIGID® SR-SERIES PRO SPOT LED

LUMENS: 3,168

» 2883127 • \$174<sup>99</sup>

Comes in a pair

### NEW RIGID® SR-SERIES PRO 10" COMBO LED

LUMENS: 7,920

» 2883123 • \$269<sup>99</sup>

### NEW RIGID® SR-SERIES PRO 10" FLOOD LED

LUMENS: 7,920

» 2883122 • \$269<sup>99</sup>

### NEW RIGID® SR-SERIES PRO 10" SPOT LED

LUMENS: 7,920

» 2883121 • \$269<sup>99</sup>

### NEW PRO ARMOR® 20" DUAL

LUMENS: 11,252

» 2883107 • \$379<sup>99</sup>

Only fits POLARIS ACE®

### NEW PRO ARMOR® CUBE FLOOD

LUMENS: 1,300

» 2882312 • \$79<sup>99</sup>

Each or single light

### NEW PRO ARMOR® CUBE SPOT

LUMENS: 1,260

» 2882076 • \$79<sup>99</sup>

Each or single light

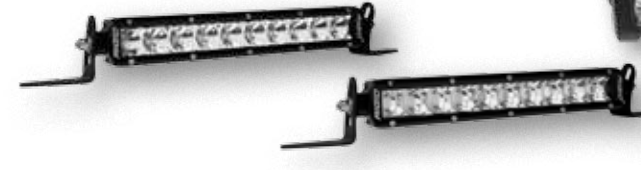

## ACCENT LIGHTING KIT

- Set includes four LED pods
- Durable off-road ready construction that is both dust- and water-resistant

## SINGLE ACCENT LIGHT

- Durable off-road ready construction that is both dust- and water-resistant
- Features CREE® LED for a long-lasting, brilliant light

COLOR	LIGHTING KIT	SINGLE LIGHT
RED	2880500 • \$149 <sup>99</sup>	2880532 • \$34 <sup>99</sup>
BLUE	2880506 • \$149 <sup>99</sup>	2880533 • \$34 <sup>99</sup>
WHITE	2881119 • \$149 <sup>99</sup>	2881176 • \$34 <sup>99</sup>
GREEN	2882378 • \$149 <sup>99</sup>	2882379 • \$34 <sup>99</sup>

ALL SPORTSMAN® MODELS AND POLARIS ACE®

## BLUE XENON HEADLIGHT BULBS

- More than 50% brighter than stock bulbs

» 2876464 • \$26<sup>99</sup>  
XP '09-14, SPORTSMAN® '05-14

## WIRING HARNESSES

### LED LIGHT BAR HARNESS

» 2882320 • \$49<sup>99</sup>  
ALL SPORTSMAN® MODELS

### LED HARNESS WITH TWO CONNECTORS

• Y-Harness requires 2882320 or 2879859 to control two cube lights with one switch

» 2879860 • \$19<sup>99</sup>

### LED LIGHT BAR HARNESS

» 2879859 • \$49<sup>99</sup>  
ALL POLARIS ACE® MODELS

\* If RIGID® determines, in its sole discretion, that your product is defective in material or workmanship, RIGID® will honor your warranty claim. In some cases the product will be replaced, depending on the specific time frame of the purchase. If the product is repaired, all parts, labor, and return shipping may be covered by RIGID®.



# OFF-ROAD GRADE AUDIO



## AUDIO PODS **POLARIS ACE**

- Two 8" coaxial speakers with 1" titanium tweeters in weatherproof enclosures
  - Self-powered 200-watt per speaker output
  - Backlit LED illumination selectable between red and blue
- » 2881227 • \$799<sup>99</sup>  
ALL POLARIS ACE<sup>®</sup> MODELS  
Requires Audio Harness (2882167)
- Rotating, low-profile, rubber isolated mounts
  - Durable black satin finish
  - Required to operate: Head unit or Bluetooth<sup>®</sup> Remote (2881470)



## BLUETOOTH<sup>®</sup> AUDIO REMOTE **POLARIS ACE**

- Bluetooth<sup>®</sup> technology allows you to play music through speakers of choice
  - Mount anywhere and control music with easy-to-use push-button pad
- » 2881470 • \$99<sup>99</sup>  
ALL POLARIS ACE<sup>®</sup> MODELS  
» 2883113 • \$129<sup>99</sup> **NEW**  
ALL POLARIS ACE<sup>®</sup> MODELS



## MTX<sup>®</sup> OVERHEAD AUDIO POD **POLARIS ACE**

- Bluetooth<sup>®</sup> connectivity for wireless audio
  - USB port for charging mobile devices in waterproof storage locker
  - LCD display shows audio information; convenient LED lights shine toward rider
  - Auxiliary connection through headphone jack
  - Dual 6" speakers and tweeters that direct sound toward rider
  - Installs in less than 15 minutes; includes all wiring
  - Durable, sealed, hard plastic black housing
  - Can be used with a roof and windshield; not compatible with Overhead Storage Bag
- » 2879703 • \$499<sup>99</sup>  
ALL POLARIS ACE<sup>®</sup> MODELS



## SOUND BAR 4 **POLARIS ACE**

- Dual mid-range/mid-bass speaker and two dedicated tweeters
  - Integrated, self-powered amplifier for easy installation
  - Bluetooth<sup>®</sup> or wired audio input with variable output
  - Large, easy-to-use external controls
  - Aluminum, black finish housing with low profile, clamp-on mounts
  - Includes mounts, audio bar, waterproof connections, and instructions
- » 2881230 • \$379<sup>99</sup>  
ALL POLARIS ACE<sup>®</sup> MODELS  
Requires Audio Harness (2882280)



## WATERPROOF BLUETOOTH<sup>®</sup> AUDIO **POLARIS ACE** **SPORTSMAN**

- Kit includes four mounting configurations
  - Mounts easily to the handlebars or roll cage or fits in your dashboard storage area
  - IPX4 -rated for water and dust resistance
  - Internal LiPo rechargeable battery provides 12 hours of music between charges
- » 2880458 • \$249<sup>99</sup>  
ALL SPORTSMAN<sup>®</sup> & POLARIS ACE<sup>®</sup> MODELS





# BE PREPARED AND GET MORE DONE



## POLARIS® SPORTSMAN® & POLARIS ACE® ESSENTIAL ACCESSORIES



### TIE-DOWN RATCHET STRAPS

- » 2859047-01 • RED \$19<sup>99</sup>
- » 2859047-02 • BLACK \$19<sup>99</sup>



### SHOCKSTRAP

- » 2883295 • 1.5" X 7' (2 PACK) \$64<sup>99</sup>
- » 2883296 • 1.5" X 15' (2 PACK) \$74<sup>99</sup>



### LOCK & RIDE PLUNGER

- » 2876420 • \$19<sup>99</sup>
- ALL SPORTSMAN® AND POLARIS ACE®



### LOCK & RIDE D-RING PLUNGER

- » 2881544 • \$24<sup>99</sup>
- ALL SPORTSMAN® AND POLARIS ACE®



### RIDE & REPAIR ESSENTIALS KIT

- 12-volt DC portable air compressor
- Tire repair kit with 6 plugs
- Basic first-aid kit with bandages, scissors, safety pins, and more
- 12-volt jumper cables
- Duct tape - 300mm x 1 roll
- Zip ties - 150mm length
- Electrical tape
- Ratchet strap - 50mm
- Microfiber cloth
- Carry bag

- » 2881207 • \$99<sup>99</sup>



### SPORTSMAN® BOOM SPRAYER - 15 GAL

- » 2882266 • \$399<sup>99</sup>
- ALL SPORTSMAN® MODELS EXCEPT TOURING



### HANDLEBAR HAND WARMERS

- Keep both hands warm while riding
- Complete kit includes all wiring

- » 2877363 • \$54<sup>99</sup>
- ALL SPORTSMAN® MODELS



### THROTTLE/THUMB WARMERS

- Keeps throttle thumb warm
- Complete kit includes all wiring

- » 2877364 • \$44<sup>99</sup>
- ALL SPORTSMAN® MODELS



### HANDLEBAR-MOUNTED MIRROR

- For added safety on or off the trail

- » 2877222 • \$34<sup>99</sup>
- ALL SPORTSMAN® MODELS



### LICENSE PLATE KIT

- » 2873270 • \$12<sup>99</sup>
- ALL SPORTSMAN® MODELS

### FOX® SHOCK: XP

- » 2879892 • \$1,199<sup>99</sup>

XP 1000 '15-16, 850/XP 1000 HL '16-18, 850/850 SP '09-16, 550 '09-14  
FOX® is a registered trademark of Fox Factory Inc.



# TOTAL FREEDOM REALIZED



POLARIS ACE® 900 XC  
HAVASU VELOCITY BLUE

Run your favorite trail in the machine you want that's built the way you want. Accessorize your Polaris ACE® 900 to express your passion, and step up your experience. Roofs, windshields, lower doors, and more await your vision.

#### SHOWN WITH:

- A. AUDIO PODS • 2881227
- B. LOWER DOOR EXTENSIONS • 2880272
- C. LOCK & RIDE CARGO BOX • 2881447
- D. XC FRONT BUMPER • 2882258
- E. LOCK & RIDE FLIP-DOWN WINDSHIELD  
HARD COAT POLY • 2882443
- F. LOCK & RIDE SPORT ROOF - POLY • 2881147





# TAKE ON

## THE TRAIL

POLARIS ACE 570 SP  
TITANIUM MATTE METALLIC



# NEW POLARIS ACE® 150

THE ONLY SINGLE SEAT  
YOUTH ATV WITH A  
FULL CAB FRAME



Make it happen. Build it the way you want. Write a story of freedom and adventure on the trail in your Polaris ACE® 570. It's there for the taking. What are you waiting for?

### SHOWN WITH:

- A. FOLDING SIDE MIRRORS • 2881517
- B. LOCK & RIDE SPORT ROOF - POLY • 2881147
- C. MTX® OVERHEAD AUDIO POD • 2879703
- D. LOCK & RIDE MID WINDSHIELD - POLY • 2879694
- E. LOWER DOOR EXTENSION • 2880272
- F. PRO ARMOR® WHEEL & TIRE SET: SIXR - LUSTER & ATTACK • 2881359
- G. POLARIS NORTHSTAR® COOLER - 30QT • 2881315
- H. SPARE TIRE MOUNT • 2881150
- I. REAR ROPS EXTENSION • 2881154

### A. POLY ROOF

» 2882263 • \$129<sup>99</sup>  
POLARIS ACE® 150 '17-18

### B. HALF WINDSHIELD

» 2882264 • \$99<sup>99</sup>  
POLARIS ACE® 150 '17-18

### C. FRONT & REAR BRUSHGUARD

» 2882472 • \$99<sup>99</sup>  
POLARIS ACE® 150 '17-18



# COMFORTABLE AND CAPABLE



**LOCK & RIDE**  
**FLIP-DOWN WINDSHIELD**  
**- HARD COAT POLY**

• In its up position, experience full protection from wind, mud, rain, or whatever you encounter

» 2882443 • \$299<sup>99</sup>

POLARIS ACE® '14-16, POLARIS ACE® 900 XC '17-18, POLARIS ACE® 900 SP '16, POLARIS ACE® 570 SP '16-17, POLARIS ACE® 570 '15-18, POLARIS ACE® 500 '17-18



**A SPORT DOORS**

- Steel frame and strong plastic exterior
- Premium fit and finish; no cutting, welding, or drilling required
- Add style with custom POLARIS ACE® Sport Door Graphics (sold separately)

» 2881429 • \$499<sup>99</sup>

POLARIS ACE® '14-16, POLARIS ACE® 900 XC '17-18, POLARIS ACE® 900 SP '16, POLARIS ACE® 570 SP '16-17, POLARIS ACE® 570 '15-18, POLARIS ACE® 500 '17-18

**B LOWER DOOR EXTENSIONS**

- Extensions install on Sport Doors (2879697, sold separately) and create a single, integrated door unit
- Extensions feature strong, durable steel frame with black hard-plastic exterior

» 2880272 • \$299<sup>99</sup>

POLARIS ACE® '14-16, POLARIS ACE® 900 XC '18, POLARIS ACE® 900 SP '16, POLARIS ACE® 570 SP '16, POLARIS ACE® 570 '15-18, POLARIS ACE® 500 '17-18



**CANVAS CAB**

• Cab provides riders with protection and enhanced comfort for a more enjoyable riding experience

• Included are: canvas roof/rear panel and canvas doors

• Components can be used to suit rider preference and the day's conditions, i.e., doors can be easily removed to suit conditions

• Doors and rear panel feature clear plastic windows for excellent visibility

• Doors feature aluminum frames with durable canvas exterior and durable, reliable hinges and latches

• Requires the use of accessory Full Poly Windshield (2879693; sold separately)

• Requires the removal of accessory Polaris ACE® Sport Doors (2879697) if previously installed

» 2880646 • \$799<sup>99</sup>

POLARIS ACE® '14-16, POLARIS ACE® 900 XC '17-18, POLARIS ACE® 900 SP '16, POLARIS ACE® 570 SP '16-17, POLARIS ACE® 570 '15-18, POLARIS ACE® 500 '17-18



**LOCK & RIDE** **FULL WINDSHIELD - POLY**

• Windshield is made of impact- and shatter-resistant 0.177" polycarbonate with hard coat on both sides

» 2879693 • \$279<sup>99</sup>

POLARIS ACE® '14-16, POLARIS ACE® 900 XC '17-18, POLARIS ACE® 900 SP '16, POLARIS ACE® 570 SP '16-17, POLARIS ACE® 570 '15-18, POLARIS ACE® 500 '17-18



**LOCK & RIDE** **MID WINDSHIELD - POLY**

• Provides protection while also allowing airflow to reach the rider

• Strong, durable, impact-resistant polycarbonate

» 2879694 • \$129<sup>99</sup>

POLARIS ACE® '14-16, POLARIS ACE® 900 XC '17-18, POLARIS ACE® 900 SP '16, POLARIS ACE® 570 SP '16-17, POLARIS ACE® 570 '15-18, POLARIS ACE® 500 '17-18



**LOCK & RIDE** **REAR PANEL - POLY**

• Can be used with other accessories such as roof, cargo bags, etc.

» 2879696 • \$179<sup>99</sup>

POLARIS ACE® '14-16, 570 SP '15-16, 570 '16

» 2881774 • \$179<sup>99</sup>

POLARIS ACE® 900 XC '17-18, POLARIS ACE® 900 SP '16, POLARIS ACE® 570 SP '17, POLARIS ACE® 570 '17-18, POLARIS ACE® 500 '17-18

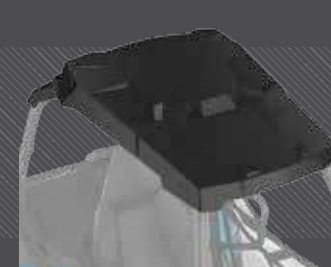

**LOCK & RIDE**  
**SPORT ROOF - POLY**

• Works with Rear Rops Extender 2881154

» 2881147 • \$199<sup>99</sup>

POLARIS ACE® '14-16, POLARIS ACE® 900 XC '17-18, POLARIS ACE® 900 SP '16, POLARIS ACE® 570 SP '16-17, POLARIS ACE® 570 '15-18, POLARIS ACE® 500 '17-18



**CANVAS ROOF**

• Roof attaches securely to vehicle frame using integrated, self-locking mounting hardware

» 2879692 • \$129<sup>99</sup>

POLARIS ACE® '14-16, POLARIS ACE® 900 XC '17-18, POLARIS ACE® 900 SP '16, POLARIS ACE® 570 SP '16-17, POLARIS ACE® 570 '15-18, POLARIS ACE® 500 '17-18



**SIDE MIRRORS**

• Hinges feature breakaway design for tight trail conditions and easy trailering

» 2881517 • \$149<sup>99</sup>

POLARIS ACE® '14-16, POLARIS ACE® 900 XC '17-18, POLARIS ACE® 900 SP '16, POLARIS ACE® 570 SP '16-17, POLARIS ACE® 570 '15-18, POLARIS ACE® 500 '17-18



**REAR VIEW MIRROR**

• Can be used in conjunction with accessories such as roof, windshield, etc.

» 2879712 • \$59<sup>99</sup>

POLARIS ACE® '14-16, POLARIS ACE® 900 XC '17-18, POLARIS ACE® 900 SP '16, POLARIS ACE® 570 SP '16-17, POLARIS ACE® 570 '15-18, POLARIS ACE® 500 '17-18



# PROTECT YOUR RIDE



**BED EXTENDER** *NEW*

- Creates up to 28 gallons of storage volume on your storage bed
- Adds 4.5" of height to the rear perimeter of storage bed
- Steel construction

» 2882886 • **\$149<sup>99</sup>**  
ALL POLARIS ACE<sup>®</sup> MODELS



**SUBZERO HARNESS** *NEW*

- Exclusive controlled deceleration tech
- Easy one-click buckle
- Secure restraint allows for improved vehicle control

» 2882281 • **\$179<sup>99</sup>**  
POLARIS ACE<sup>®</sup> 500 '18, POLARIS ACE<sup>®</sup> 570 '18, POLARIS ACE<sup>®</sup> 900 XC '18

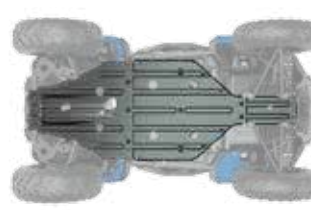

**SKID PLATE**

- Strong, durable, lightweight 3/8" HMW (high-molecular weight) polyethylene construction

» 2880543 • **\$329<sup>99</sup>**  
POLARIS ACE<sup>®</sup> '14-16, POLARIS ACE<sup>®</sup> 900 SP '16, POLARIS ACE<sup>®</sup> 570 SP '16-17, POLARIS ACE<sup>®</sup> 570 '15-18, POLARIS ACE<sup>®</sup> 500 '17-18



**FRONT RACK EXTENDER** *NEW*

- Increase front rack carrying capacity
- 4"-tall support design around the front and side perimeter of the rack

» 2882885 • **\$99<sup>99</sup>**  
ALL POLARIS ACE<sup>®</sup> MODELS

- Steel construction
- Angular design enhances the look of your machine
- Easily mounts with four bolts



**XC BUMPER**

- Contoured steel tube design fits perfectly and flows with the sculpted design cues of the Polaris ACE<sup>®</sup> 900 XC

» FRONT • 2882258 • **\$139<sup>99</sup>**  
POLARIS ACE<sup>®</sup> 900 XC '17-18



**XC BUMPER**

- Contoured steel tube design fits perfectly and flows with the sculpted design cues of the Polaris ACE<sup>®</sup> 900 XC

» REAR • 2882259 • **\$129<sup>99</sup>**  
POLARIS ACE<sup>®</sup> 900 XC '17-18



**EXTREME BRUSHGUARD**

- Strong 1.25" (3.2cm) diameter steel tube construction with a durable, scratch-resistant black powder-coated finish

» FRONT • 2882504 • **\$229<sup>99</sup>**  
POLARIS ACE<sup>®</sup> '14-16, POLARIS ACE<sup>®</sup> 900 SP '16, POLARIS ACE<sup>®</sup> 570 SP '16-17, POLARIS ACE<sup>®</sup> 570 '15-18, POLARIS ACE<sup>®</sup> 500 '17-18



**EXTREME BRUSHGUARD**

- Strong 1.25" (3.2cm) diameter steel tube construction with a durable, scratch-resistant black powder-coated finish

» REAR • 2882924 • **\$149<sup>99</sup>**  
POLARIS ACE<sup>®</sup> '14-16, POLARIS ACE<sup>®</sup> 900 SP '16, POLARIS ACE<sup>®</sup> 570 SP '16-17, POLARIS ACE<sup>®</sup> 570 '15-18, POLARIS ACE<sup>®</sup> 500 '17-18



**FENDER FLARE KIT**

- Extends bodywork additional 3" for extra protection from mud and water

» 2879718 • **\$249<sup>99</sup>**  
POLARIS ACE<sup>®</sup> 900 SP '16, POLARIS ACE<sup>®</sup> 570 SP '16-17, POLARIS ACE<sup>®</sup> 570 '15-17, POLARIS ACE<sup>®</sup> 500 '17, POLARIS ACE<sup>®</sup> '14-16



**LOW PROFILE ROCK SLIDERS**

- Low-profile design hugs bodywork without compromising ground clearance

» 2881151 • **\$149<sup>99</sup>**  
POLARIS ACE<sup>®</sup> 900 SP '16, POLARIS ACE<sup>®</sup> 570 SP '16-17, POLARIS ACE<sup>®</sup> 570 '15-17, POLARIS ACE<sup>®</sup> 500 '17, POLARIS ACE<sup>®</sup> '14-16  
Expanding Anchor Technology - minimal tools required



**NERF BARS**

- 5" kick-out protects the side of the vehicle, acting as a buffer between the vehicle and obstacles

» 2879700 • **\$199<sup>99</sup>**  
POLARIS ACE 900 SP '16, POLARIS ACE 570 SP '16-17, POLARIS ACE 570 '15-17, POLARIS ACE 500 '17, POLARIS ACE '14-16



**BODY ARMOR**

- Helps protect vehicle plastics

» 2882087 • **\$219<sup>99</sup>**  
POLARIS ACE<sup>®</sup> '14-16, POLARIS ACE<sup>®</sup> 570 SP '16-17, POLARIS ACE<sup>®</sup> 570 '15-17, POLARIS ACE<sup>®</sup> 900 SP '16, POLARIS ACE<sup>®</sup> 500 '17



**LOOK & RIDE**

**REAR CARGO BOX**

- Installs without tools using twin Lock & Ride<sup>™</sup> plungers, locks into vehicle's cargo space
- Handles make it easy to carry Cargo Box to and from vehicle
- D-rings on top of box serve as tie-down points for bungees, straps, cargo nets, etc.

» 2881447 • **\$249<sup>99</sup>**  
POLARIS ACE<sup>®</sup> '14-16, POLARIS ACE<sup>®</sup> 900 XC '17-18, POLARIS ACE<sup>®</sup> 900 SP '16, POLARIS ACE<sup>®</sup> 570 SP '16-17, POLARIS ACE<sup>®</sup> 570 '15-18, POLARIS ACE<sup>®</sup> 500 '17-18



**REAR ROPS EXTENSION**

- Attaches to existing frame for additional protection
- Allows for mounting of accessory Spare Tire Holder (2881150)
- Works with Storage Box and Performance Rear Bumper (2881149)

» 2881154 • **\$249<sup>99</sup>**  
POLARIS ACE<sup>®</sup> 900 SP '16, POLARIS ACE<sup>®</sup> 570 SP '16-17, POLARIS ACE<sup>®</sup> 570 '15-18, POLARIS ACE<sup>®</sup> 500 '17-18, POLARIS ACE<sup>®</sup> '14-16

**SPARE TIRE MOUNT**

- Securely holds spare tire and wheel across top of rear ROPS cage

» 2881150 • **\$119<sup>99</sup>**  
POLARIS ACE<sup>®</sup> '14-16, POLARIS ACE<sup>®</sup> 900 SP '16, POLARIS ACE<sup>®</sup> 570 SP '16-17, POLARIS ACE<sup>®</sup> 570 '15-18, POLARIS ACE<sup>®</sup> 500 '17-18  
Requires Rear ROPS Extension (2881154)  
Wheel/Tire not included



**SIDE BAGS**

- Bag has a zippered compartment to securely hold cargo and a mesh outside pocket
- Sold as a set of 2

» 2880542 • **\$79<sup>99</sup>**  
ALL POLARIS ACE<sup>®</sup> MODELS WITHOUT DOORS



**TRAIL BAG**

- Securely holds cargo in four zippered compartments
- Adjustable Velcro<sup>®</sup> straps secure bag to vehicle frame

» 2879705 • **\$69<sup>99</sup>**  
POLARIS ACE<sup>®</sup> '14-17





# SPECIFIC NEEDS, SPECIFIC OILS

Polaris invests millions in engine development, and part of that investment is making sure its lubricants—critical to engine performance—are the right formula for your specific engine. The amount of testing data and engineering resources used in developing Polaris lubricants would overwhelm an aftermarket company. Therefore, the aftermarket must spec an oil to an industry-wide standard that must account for a variety of operating parameters.

PS-4 is designed specifically for Polaris 4-cycle engines and has high film strength and wear protection under extreme loads and temperatures. Exclusive anti-wear additives protect engine parts with extra rust and corrosion protection.

### PS-4 FULL-SYNTHETIC OIL

• PS-4 is optimal for ambient operating temperatures of -40° F to 100° F

- » 1 QT. • 2876244
- » 1 GAL. • 2876245
- » 16 GAL. • 2876247
- » 55 GAL. • 2876246
- » 330 GAL. • 2878814

### PS-4 OIL CHANGE KIT

• Contains the correct amount of oil for your vehicle and correct oil filter

- » 2202166 SINGLE 570, TWIN 600, TWIN 700, TWIN 800
- » 2877473 330-500, SPORTSMAN® 550/850/1000
- » 2880913 POLARIS ACE®/ETX 325
- » 2879323 RANGER®/RZR 900/1000

### ORV MAINTENANCE KIT

• Includes: 1.5 qt.s AGL, 1 qt. Angle Drive Fluid, 1 pint Demand Drive Fluid, 1-3oz. tube of All-Season Grease

- » 2880425

### PS-4 EXTREME-DUTY FULL-SYNTHETIC OIL

• PS-4 Extreme Duty is optimal for ambient operating temperatures of 0° F to 130° F

- » 1 QT. • 2878920
- » 1 GAL. • 2878919
- » 16 GAL. • 2879003
- » 55 GAL. • 2879002
- » 330 GAL. • 2879001

### PS-4 EXTREME-DUTY OIL CHANGE KIT

• Contains the correct amount of oil for your vehicle and correct oil filter

- » 2879004 SINGLE 570, TWIN 600, TWIN 700, TWIN 800
- » 2878924 330-500, SPORTSMAN® 550/850/1000
- » 2879324 RANGER®/RZR® 900/1000
- » 2881697 RZR® TURBO

## POLARIS® PS-4 VS THE COMPETITION

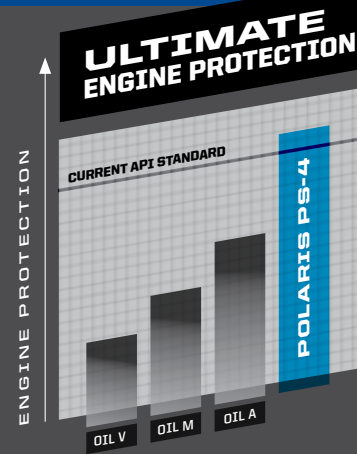

Polaris® PS-4 oils exceed the latest industry protection standard as set by the API, while the competition uses standards from years ago. Our proprietary additives clean and protect critical engine parts under high operating temperatures.

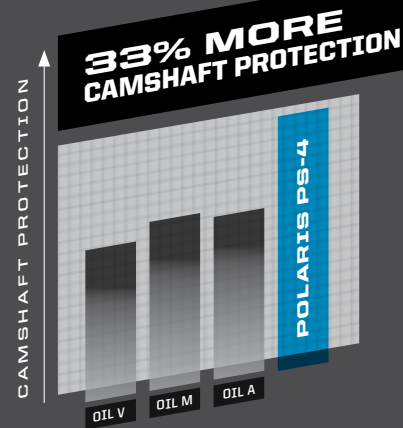

When tested against competitive oils, camshaft bearing races and lobes exhibit less wear when protected by Polaris® PS-4 oil.

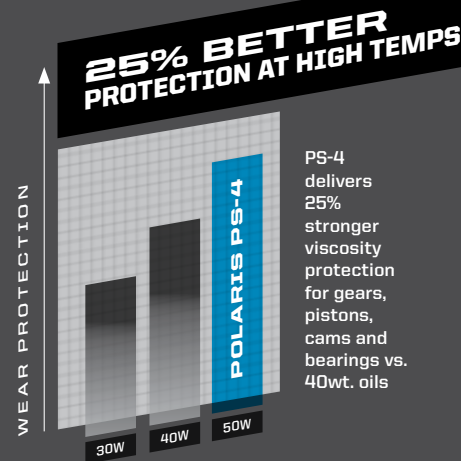

PS-4 delivers 25% stronger viscosity protection for gears, pistons, cams and bearings vs. 40wt. oils

**WHY VISCOSITY MATTERS:** Polaris® engines are designed to operate using oils rated at a specific viscosity. Viscosity is the measure of an oil's resistance to flow and shear and a way to gauge an oil's "film strength", which is a critical component in preserving engine life when an oil is subject to high heat or heavy loads.

## ENGINEERED TO MAXIMIZE THE LIFE OF YOUR RIDE

All Polaris® fluids—from anti-freeze to brake fluid—are developed for your vehicle. Trust the only fluids perfectly engineered for your needs.

### AGL

A proprietary blend of additives designed to optimize Polaris® ORV transmission life. Extreme pressure additives protect gears, drive chain, and bearings from scoring and wear. Unlike typical gear case oils, AGL's unique viscosity range allows instant flow and film protection in extreme cold or high heat environments

- » 1 QT. • 2878068
- » 1 GAL. • 2878069
- » 2.5 GAL. • 2878070
- » 55 GAL. • 2879594

Proper lubricant application and timing will ensure optimal vehicle performance. Please refer to your owner's manual for lubricant change interval schedules.

### ANGLE DRIVE FLUID

ATV Angle Drive Fluid offers extreme pressure, anti-wear, and high viscosity film lubrication for maximum protection of Polaris® ATV angle gear drive systems conditions

- Excellent corrosion protection for long component life under severe operating conditions
- » 1 QT. • 2876160
- » 2.5 GALLON • 2872276

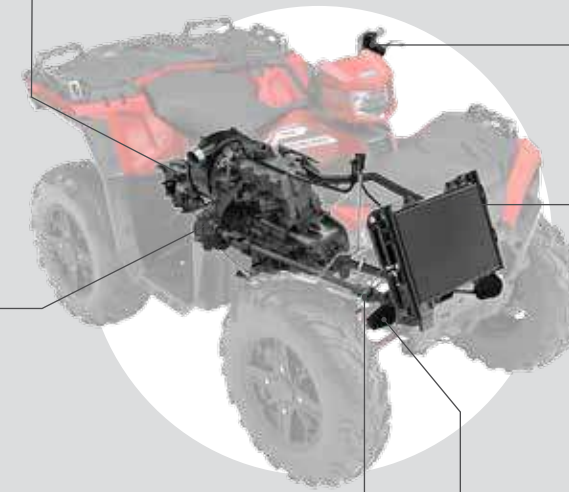

### DOT 4 BRAKE FLUID

Polaris® DOT 4 Brake Fluid is a high quality brake fluid designed for use in Polaris® hydraulic brakes. Superior high-temp characteristics plus anti-corrosive additives extend the life of brake system components and provide consistent, positive braking

- » 12 OZ. • 2872189

### ANTI-FREEZE

Polaris® Extended Life Coolant contains organic acid technologies to prevent corrosion on metal components, eliminate scaling, and maximize cooling system performance

- » 1 QT. • 2880514
- » 1 GAL. • 2880513
- » 55 GAL. • 2880512

### U-JOINT GREASE

Polaris® U-Joint Grease is a heavy-duty lubricant formulated with molybdenum disulfide to accept the high shock applications of Polaris® ATV shaft drive universal joints

- » 3 OZ. • 2871515
- » 14 OZ. • 2871551

### DEMAND DRIVE FLUID

Engineered specifically for Polaris® ORV front drive systems. Provides positive 4WD engagement in extreme cold or high heat conditions. Unique friction additives protect internal components under heavy loads and promotes positive engagement

- » 1 QT. • 2877922
- » 2.5 GAL. • 2877923

## LUBE ACCESSORIES



### GREASE GUN KIT

- » 2871312 \$39<sup>99</sup>

FITS 2871322 ALL-SEASON AND 2871322 U-JOINT 3 OZ

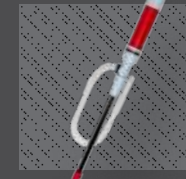

### 2D BATTERY-OPERATED SIPHON PUMP

- Liquid transfer pumps 5-6 quarts/min suctioning power.

• Use with gas, water, oil, and other non-corrosive liquids

- » 2830513 • \$16<sup>99</sup>



### FLEX SPOUT

• Convenient easy pour flex spout fits all Polaris® quart, gallon, and 2.5 gallon bottles

- » 2871285 • \$3<sup>99</sup>

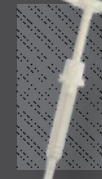

### PUMP

- » 2870465 \$7<sup>99</sup>

ATTACHES TO 1- OR 2.5-GALLON BOTTLE FOR EASY, NO-D RIP DISPENSING



### PREMIUM GAS SHOCK OIL

- » 1 QT. • 2870995
  - » 2.5 GAL. • 2872279
- FOX® REBUILDABLE SHOCKS

### 10WT GAS SHOCK OIL

- » 1 QT. • 2874124
- WALKER EVANS® REBUILDABLE SHOCKS

### ANGLE DRIVE FLUID

- » 1 QT. • 2876160
  - » 2.5 GAL. • 2872276
- SPORTSMAN®, RANGER®, RZR® ANGLE DRIVE GEAR CASE SYSTEMS

### CHAIN LUBRICANT

- » 16 OZ. AEROSOL 2872348

### ALL-SEASON GREASE TUBE

- » 3 OZ. 2871322
- » 14 OZ. 2871423



### CARBON CLEAN

• Polaris® Carbon Clean prevents ethanol corrosion, stabilizes fuel, cleans fuel injectors, piston ring lands, intake systems and combustion chambers. Helps maintain peak HP and improves fuel economy

- » 12 OZ. • 2881413



### ADVANCED FUEL TREATMENT

• Advanced Fuel Treatment prevents ethanol corrosion and stabilizes fuel for up to 2 years. Dual-antioxidant formula protects against gum and varnish for easy starting

- » 12 OZ. • 2881416
- » 2.5 GAL. • 2881417



### SCENTED ADVANCED FUEL TREATMENT

• 1 oz pouch treats 5 gallons of fuel

• Scented formulas provide pleasant fragrance through the exhaust system

• Alcohol free: safe for all powerports applications

- » MINT • 2881418
- » STRAWBERRY • 2881419
- » UNSCENTED • 2881420
- » 25 - 1 OZ. POUCHES OF EACH FORMULA • 2881421



# FOR THE LIFE OF YOUR RIDE

## THE KEY TO KEEPING YOUR POLARIS® OFF-ROAD VEHICLE PERFORMING

as well as the day you brought it home is proper maintenance. Items like belts, filters and batteries represent only a few of these critical items engineered specifically by Polaris®.

CHECK OUT OUR [PARTS FINDER ON POLARIS.COM](https://www.polaris.com) FOR EASY PARTS LOOK-UP, PARTS IDENTIFICATION, VIEWS OF ASSEMBLIES AND MORE!

## POLARIS ENGINEERED™ DRIVE BELTS

Polaris Engineered™ belts deliver unmatched performance for your off-road vehicle. Our belts are developed and tested on all our engines for all environments and conditions. This ensures it doesn't merely fit your vehicle—it outperforms your expectations.



### TESTED, PERFECTED

We test each belt on the intended vehicle – we don't try to make an existing belt "just work." The tolerances are tighter than aftermarket alternatives, meaning less heat for your engine, and you won't have to recalibrate your clutch in order to run at the engine's optimal RPM. Aftermarket belts fluctuate in and out of the optimal power band, which means more wear on your clutch and more maintenance needed to maintain power.

### OUR INVESTMENT

We average **20,000** miles of field testing and **thousands of dyno hours** on each engine to ensure the Polaris® drive belt on your machine gives you peak performance with each and every ride.

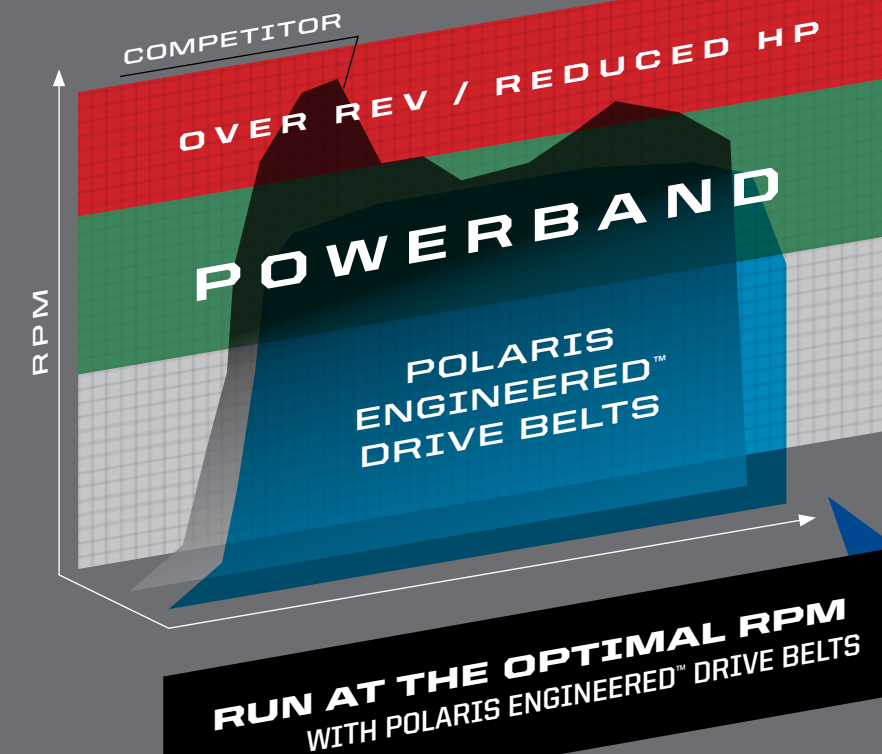

## MAINTENANCE SCHEDULE

CHECK YOUR OWNER'S MANUAL FOR ADDITIONAL RECOMMENDED SERVICE ITEMS AND VEHICLE SPECIFIC TIMING

25 HRS/500 MI

### BREAK-IN MAINTENANCE

**ENGINE OIL:**  
CHANGE

**GENERAL LUBRICATION:**  
ALL FITTINGS, PIVOTS, CABLES, ETC.

**AIR FILTER:**  
INSPECT & CLEAN  
REPLACE AS NEEDED

100 HRS/1000 MI

### 12 MONTHS

**ENGINE OIL:**  
CHANGE

**DRIVE BELT:**  
INSPECT & ADJUST  
REPLACE AS NEEDED

**TRANSMISSION FLUID:**  
CHANGE

150 HRS/1500 MI

### 18 MONTHS

**ENGINE OIL:**  
CHANGE

**BATTERY:**  
TEST, CLEAN, &  
CHECK FLUID LEVEL  
REPLACE AS NEEDED

**DRIVE BELT:**  
INSPECT & ADJUST  
REPLACE AS NEEDED

**TIRES:**  
INSPECT CONDITION  
& PRESSURE

200 HRS/2000 MI

### 24 MONTHS

**ENGINE OIL:**  
CHANGE

**BRAKE PADS & FLUID:**  
INSPECT & CLEAN  
REPLACE AS NEEDED

**SPARK PLUGS:**  
INSPECT  
REPLACE AS NEEDED

350 HRS/3500 MI

### 30 MONTHS

**ENGINE OIL:**  
CHANGE

**BATTERY:**  
TEST, CLEAN, &  
CHECK FLUID LEVEL  
REPLACE AS NEEDED

**DRIVE BELT:**  
INSPECT & ADJUST  
REPLACE AS NEEDED

**GENERAL LUBRICATION:**  
ALL FITTINGS, PIVOTS, CABLES, ETC.

500 HRS/5000 MI

### 36 MONTHS

**ENGINE OIL:**  
CHANGE

**AIR FILTER:**  
INSPECT, CLEAN  
REPLACE AS NEEDED

**COOLANT:**  
CHECK LEVEL  
REPLACE EVERY 2 YEARS

**GEARCASES:**  
CHECK OIL LEVEL



# POLARIS POWER®

**POWERFUL, PORTABLE, DURABLE.** These digital inverter generators are built to match your outdoor lifestyle, and are tested to the same rigorous standards as every Polaris® product. The 1000-watt generator is best for running a single device with low wattage requirements. The 2000-watt generator runs multiple devices with added surge protection and start-up wattage. The 3000-watt generator handles high-output needs and runs multiple devices. It also includes electric start for ease of use when needed.

## WHICH GENERATOR FITS YOUR NEEDS?

- 1 START** by adding up the running watts of everything you might power at the same time. (use the chart on the left)
- 2 NEXT**, pick the device with the highest running watts, and add its starting watts to the previous total.
- 3 NOW** you have the total amount of watts you need from your generator. Select a generator with a slightly higher wattage.

	Startup Wattage	Running Wattage
55" LCD TV	0	150
CROCK POT	0	200
RADIO	0	50-200
LAPTOP	0	200-250
625W MICROWAVE	0	625
FRIDGE OR FREEZER	700	700
COFFEE MAKER	1300	800
SUMP PUMP: ½ HP	1300	800
BLENDER	1000	1000
ELECTRICAL GRIDDLE	0	1500
7¼" CIRCULAR SAW	1700	1400
AIR CONDITIONER	1500	1500



### POLARIS POWER® INVERTER GENERATORS

- » 1000 WATT • P136DGNANA • \$549<sup>99</sup>
- » 2000 WATT • P136DGBNA • \$799<sup>99</sup>
- » 3000 WATT • P136DGCNA • \$1,599<sup>99</sup>



#### POLARIS POWER® CABLE KIT

- Use a parallel cable kit to easily connect two Polaris Power® generators together to increase the total power available to a load

» 3410281 • \$149<sup>99</sup>



#### POLARIS POWER® TIE-DOWN LEADS

- Secure your Polaris Power® Generator by inserting the Lock & Ride® Tie Down Leads into the handle and running a strap across to tie down the generator
- Secures Lock & Ride® accepting gear
- Safely provides a point for 1" wide tie down strap

» 2880959 • \$12<sup>99</sup>



#### POLARIS POWER® COLD WEATHER KIT

- Ensure smooth running of your Polaris® Generator in sub-zero temperatures
- Prevents ice blockage in the crankcase breather tube, which may lead to operational issues including oil leakage
- Installation required, no need to disconnect for warm weather operation
- Exclusively designed for use with Polaris® P1000i & P2000i inverter generators

» 2881433 • \$99<sup>99</sup>



#### POLARIS POWER® GENERATOR OIL

Corrosion inhibitors protect against rust and oxidation during long-term storage.

» 1 QUART • 2879383

#### POLARIS POWER® GENERATOR STORAGE COVERS

- Keep your generator looking like new with a strong, durable cover that is resistant to mold, mildew, tears and abrasions

» 1000 WATT COVER • 2686441  
\$29<sup>99</sup>

» 3000 WATT COVER • 2686443  
\$39<sup>99</sup>

» 2000 WATT COVER • 2686442  
\$34<sup>99</sup>



### POLARIS® FLEX JUMPSTARTER

12,000 mAh capacity. Two 5V/2.1A USB outputs, 200-lumen flashlight and a digital battery-life monitor. Includes storage case, smart jumper cables, car charger, wall charger, and user guide. 1-year limited warranty.

» 2830495 • \$119<sup>99</sup>



Never let a dead vehicle battery slow you down again. The Polaris® Flex Jump-starter is a compact solution that provides the power to get your ride started. Flex is small enough to be stored in your glovebox, and holds its charge so you can count on it when it's needed. In addition to being able to jumpstart ATVs, ORVs, snowmobiles, motorcycles, cars, & trucks, Flex can also charge any USB capable device through its dual USB outlets. Flex has the ability to jumpstart up to a 6.4L engine.

## BatteryMINDER®

Make sure your vehicle's battery is properly maintained and ready for when you need it the most with a BatteryMINDER®. A tired battery is waiting for the perfect time to ruin your day, so make sure it gets charged and cycled properly. Easily one of the most essential pieces of equipment every garage needs.



#### BATTERYMINDER® 1510 1.5-AMP

- Recovers weak batteries
- Ambient temperature sensor with wide operating range ensures the battery will never be overcharged or undercharged regardless of temperature extremes
- Extends battery life up to four times when compared to new batteries not being properly charged or maintained over their lifetime
- Automatic full-time high frequency (not high voltage) pulse type desulfation
- Reverse polarity, short circuit, and over temperature protection

» 2830404 • \$64<sup>99</sup>

#### BATTERYMINDER® 2012 AGM 2-AMP

- Designed for High-Performance Specialty AGM Sealed Batteries
- Guaranteed to never overcharge, regardless of how long connected
- Temperature compensation ensures proper charge in hot or cold environments
- Ambient temperature sensor with wide operating range ensures the battery will never be overcharged or undercharged regardless of temperature extremes
- Maximizes battery life and capacity, reconditions weak batteries

» 2830438 • \$99<sup>99</sup>

#### BATTERYMINDER® 1.5 AMP CONVERTIBLE

- BatteryMINDER® 1.5 AMP On-board or Benchtop Charger/Maintainer
- Complete with two mounting brackets for multiple vehicles/locations, fully-insulated battery clips, and ring terminal-assembly for permanent direct-to-battery attachment.
- Charges, Maintains, Recovers 12-volt batteries
- Maintains up to four batteries at a time
- Attaches to battery while in vehicle or for use on benchtop
- Guaranteed to never under- or overcharge
- Recovers and reconditions deeply discharged batteries automatically, using high-frequency pulse type desulfation circuitry
- Can extend battery life up to four times

» 2830511 • \$74<sup>99</sup>

#### BATTERYMINDER® EZ CONNECT

- Allows for quick and easy connecting and disconnecting of your BatterMINDER, includes a set of ring terminals

» 2830411 • \$34<sup>99</sup>

#### BATTERYMINDER® 12' CABLE

- Made with heavy-duty 16 gauge black zip cord featuring automotive SAE bullet connectors

» 2830410 • \$12<sup>99</sup>

#### BATTERYMINDER® SPLITTER

- A simple, safe, and affordable way to connect two batteries simultaneously for easy battery maintenance, cap includes a set of ring terminals

» 2830409 • \$24<sup>99</sup>

#### BATTERYMINDER® RING TERMINAL

- Features 24" long 18-gauge wire
- Plug has standard 5/16" negative and 3/8" positive terminals
- Replaceable 15-amp in-line fuse for circuit protection
- Uses SAE quick connector and cap

» 2830437 • \$9<sup>99</sup>



# TOOL STORAGE SOLUTIONS

# 1

Give your tools a dedicated spot with a properly sized rolling base. Extra-deep drawers are great for storing power tools and bulky items.

## CHOOSE YOUR BASE

Raise-and-release drawer pulls keep drawers secure when moving

Drawers use roller-bearing glides

Full-width wrap-around aluminum drawer pulls



### POLARIS® 30" 5-DRAWER ROLLER CABINET

• 30¾" W × 41" H × 20½" D  
» TEXTURED FINISH 2830406\* • \$849<sup>99</sup>

Two extra-deep drawers allow storage of large and bulky tools



### POLARIS® 41" 11-DRAWER ROLLER CABINET

• 41" W × 41½" H × 18" D  
» TEXTURED FINISH 2830408\* • \$1,099<sup>99</sup>  
» HIGH-GLOSS FINISH 2830451\* • \$999<sup>99</sup>



### POLARIS® 72" 19-DRAWER ROLLER CABINET

• 72" W × 47" H × 25" D  
» HIGH-GLOSS FINISH 2830492\* • \$2,499<sup>99</sup>

Three extra-long drawers provide storage for tools of all shapes and sizes

# 2

Polaris® offers two types of tops: Portable and permanent.

## CHOOSE YOUR TOP



### POLARIS® 30" PORTABLE WORKSTATION

• 30¾" W × 20½" H × 17½" D  
» TEXTURED FINISH 2830405 • \$749<sup>99</sup>  
TOOLS NOT INCLUDED



### POLARIS® 41" PORTABLE WORKSTATION

• 41" W × 21½" H × 17½" D  
» TEXTURED FINISH 2830407 • \$799<sup>99</sup>  
TOOLS NOT INCLUDED



### POLARIS® 41" STANDARD TOP CHEST

• 40½" W × 20½" H × 19¾" D  
» HIGH-GLOSS FINISH 2830450 • \$699<sup>99</sup>\*



### POLARIS® 72" STAINLESS STEEL TOP

• 72" W × 1" H × 25" D  
» 2830496 • \$429<sup>99</sup>

\* Tools not included

## DON'T FORGET THE FINISHING TOUCHES

# 3

Complete the organizing with a strategically placed caddy.

## UPGRADE



### POLARIS POWER® TOOL CADDY

• Hangs from fence rail of roller tool cabinets  
» SILVER • 2830430 • \$69<sup>99</sup>



### POLARIS® HAND TOOL CADDY

» SILVER • 2830431 • \$39<sup>99</sup>



### POLARIS® BADGES

» RANGER® • 2830413 \$24<sup>99</sup>  
» RZR® NOT SHOWN 2830412 \$24<sup>99</sup>

## FINISH YOUR GARAGE



### POLARIS® MAGNETIC PARTS TRAY

» SILVER • 2830432 • \$11<sup>99</sup>

### POLARIS® 33" TELESCOPIC MAGNET

» BLACK • 2830435 • \$3<sup>99</sup>



### POLARIS® 12" HI-TORQUE RATCHETING DRIVER

» BLACK / BLUE • 2830434 • \$18<sup>99</sup>

### POLARIS® LED POCKET FLASHLIGHT

» BLACK • 2830436 • \$24<sup>99</sup>



### POLARIS® HEAVY-DUTY SCRUBBER WIPES

» 90 COUNT 2830441 • \$19<sup>99</sup>



### POLARIS® SHOP TOWELS

» 200 COUNT SHOP TOWEL ROLL WITH DISPENSER 2830402 • \$22<sup>99</sup>  
» 200 COUNT REFILL 2830403 • \$15<sup>99</sup>  
» 64 COUNT SHOP TOWEL REFILL • 2830440 • \$3<sup>99</sup>

# NEW



## ROLL IT WHERE YOU NEED IT

Inspired by the carts that top racing teams use, this cart offers the best in storage and portability. Whether in the shop or out in the field, your tools go where you need them the most.

### TOOL CART

- Rolling design allows for maximum portability
- Multiple-depth drawers securely hold hand tools, power tools, and more
- Large tires for performance in all types of terrain
- Take your tools where you need them easily and securely

» 79 cm wide X 48.6 cm deep X 100 cm high 2830512 • \$799<sup>99</sup>



# ELEVATE YOUR WORK



## POLARIS® VEHICLE LIFT

- Get fast, easy access to the underside of your vehicle
- Manual and pneumatic operation available
- Raises vehicle up to 81 cm to make repairs & maintenance faster and easier
- Dual-locking safety latch for added safety

» 1205 LB (567 KG) 2830424 • **\$699<sup>99</sup>**  
 » 2300 LB (1043 KG) 2830425 • **\$1199<sup>99</sup>**

## POLARIS® VEHICLE LIFT ATTACHMENTS

- » RZR | RANGER 2830428 • **\$229<sup>99</sup>**
- » ATV/POLARIS ACE 2830427 • **\$169<sup>99</sup>**
- » SNOWMOBILE 2830426 • **\$169<sup>99</sup>**



## POLARIS® X3 CREEPER

- Three positions: flat, 45-degree angle, or seated work stool
- Helps you perform any repair with ease
- Stay dry and warm away from cold, wet cement floors
- Easily stores away when not in use

» BLACK • 2830429 • **\$149<sup>99</sup>**

## PREMIUM TIRE SEALANT

- Instantly seals and repairs rim, bead leaks, and punctures up to 1/4" on standard tires, and 3/4" on heavy ply tires
- Helps maintain air pressure for the life of the tire
- Helps seal the tire bead against the wheel
- 100% water soluble for easy cleanup.
- Will not rust, corrode, or pit wheels
- Creates permanent repair
- Remains fluid and effective in temperatures down to -45° F
- Easily installed through existing tire valve stem with valve core removed

» 32 OZ. • 2830484 • **\$19<sup>99</sup>**  
 » 1 GALLON • 2830485 • **\$69<sup>99</sup>**  
 » 5 GALLON • 2830486 • **\$289<sup>99</sup>**  
 » 5 GALLON PUMP • 2830487 • **\$129<sup>99</sup>**  
 » 55 GALLON • 2830489  
 » 275 GALLON • 2830488

## HOW IT WORKS

Tire sealant remains liquefied inside your tire until some sort of leak develops in the tire or wheel.

Once a leak occurs, the tire sealant rushes out of the tire and quickly creates a permanent solid plug.

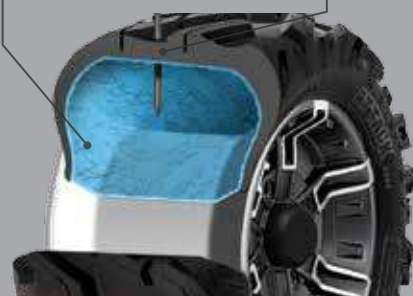

The sealant creates a permanent solid plug and maintains the pressure of the tire so you can continue your ride.

# KEEP IT CLEAN

## PRE-TREAT

### MUD SHIELD® PRE-TREATMENT

- Inhibits the adhesion of dirt, mud, and snow, making cleaning your vehicle faster and easier.
- » 16 OZ. AEROSOL • 2830208 • **\$8<sup>99</sup>**

### NEVER RUST SPRAY®

- Synthetic formula highly resistant to water protects against rust and corrosion while lubricating metal surfaces.
- » 16 OZ. AEROSOL • 2830209 • **\$9<sup>99</sup>**

## CLEAN

### XP WASH®

- Foaming, highly-concentrated wash easily removes the most stubborn and intense dirt build-up.
- » 32 OZ. • 2830203 • **\$9<sup>99</sup>**

### XP SPRAY WASH®

- Effortless biodegradable, high-performance wash ideal for removing dirt, oils and carbon—simply spray on, spray off and go.
- » 32 OZ. • 2830202 • **\$11<sup>99</sup>**

### ALL-PURPOSE CLEANER

- Professional grade, non-streak, foam formula cuts through grease dirt and film leaving an invisible, dirt-resistant barrier for long-lasting results.
- » 16 OZ. • 2830205 • **\$8<sup>99</sup>**

### GLASS CLEANER

- Heavy-duty foam non-streak formula cuts through grease, dirt, dried bugs and film leaving a crystal clear dirt-resistant barrier for long-lasting results.
- » 16 OZ. • 2830443 • **\$3<sup>99</sup>**

## SHINE

### POLARIS® POLISH

- Easy protection and shine—spray on, wipe off, and go. For ideal use on painted and plastic surfaces. Contains carnauba wax.
- » 16 OZ. • 2830207 • **\$6<sup>99</sup>**

### INSTANT SHINE & DETAILER

- Spray and wipe formula—cleans, polishes, and protects plastic and painted surfaces.
- » 16 OZ. • 2830204 • **\$7<sup>99</sup>**

## TRAILERING



### RampPro BY CALIBER®

- Designed for ATVs and UTVs up to 50" wide
- Integrated grip glides for ultimate traction
- Sides fold for compact transportation
- » 52" x 90" • 2883005 • **\$399<sup>99</sup>**

### ALUMINUM ARCHED LOADING RAMPS

- » 2,000 LB (907.2 KG) CAPACITY 76" x 12" 2875384 • **\$209<sup>99</sup>**
- » 3,000 LB (1361 KG) CAPACITY 88" x 12" 2875386 • **\$339<sup>99</sup>**

### LIGHTWEIGHT TRI-FOLD RAMPS

- Ramp folds up for transport
- Capacity for up to 1,500 lb (680.7 kg)
- Safety straps included
- » 72" x 51" • 2875385 • **\$229<sup>99</sup>**
- » 82" x 51" • 2875860 • **\$269<sup>99</sup>**

### FOLDING ALUMINUM ARCHED RAMPS

- Ramp folds up for transport
- Capacity up to 1,500 lb (680.7 kg)
- Safety straps included
- » 88" x 12" • 2875387 • **\$279<sup>99</sup>**

### RECEIVER HITCH

- » 2" RECEIVER • 2875320 • **\$39<sup>99</sup>**
- » FRONT HITCH RECEIVER • 2878846 • **\$119<sup>99</sup>**



### TRAILER BALL 3/4" SHANK

- » 17/8" • 2877602 • **\$11<sup>99</sup>**
- » 2" • 2877603 • **\$11<sup>99</sup>**



### TIE-DOWN RATCHET STRAPS

- 1 1/2" shockstrap ratchet with safety strap
- » 2859047-01 • RED • **\$19<sup>99</sup>**
- » 2859047-02 • BLACK • **\$19<sup>99</sup>**



### TRAILERING COVERS BY POLARIS®

- » 2876614 • **\$149<sup>99</sup>** ALL SPORTSMAN® EXCEPT 300/400, X2, TOURING
- » 2877999 • **\$149<sup>99</sup>** ALL SPORTSMAN® TOURING
- » 2877998 • **\$149<sup>99</sup>** SPORTSMAN® X2
- » 2880056 • **\$219<sup>99</sup>** ALL POLARIS ACE® EXCEPT 900 XC



## SHOP CLEANERS

### ALL-PURPOSE CLEANER PLUS

- Professional-grade formula removes built-up stains from shop floors, work benches, and other hard surfaces. VOC-free, environmentally-friendly, and biodegradable.
- » 1 GAL. • 2830414 • **\$16<sup>99</sup>**
- » 5 GAL. • 2830416 • **\$59<sup>99</sup>**

### VEHICLE & EQUIPMENT WASH

- Concentrated professional grade formula powers through vehicle buildup, dirt, and grease with a spot-free rinse. Treat up to 32 gals. Biodegradable.
- » 1 GAL. • 2830417 • **\$16<sup>99</sup>**
- » 5 GAL. • 2830422 • **\$59<sup>99</sup>**

### HD CLEANER & DEGREASER

- Professional-grade, biodegradable, high-foaming formula dissolves and removes tough stains and soils.
- » 1 GAL. • 2830418 • **\$19<sup>99</sup>**
- » 5 GAL. • 2830420 • **\$79<sup>99</sup>**



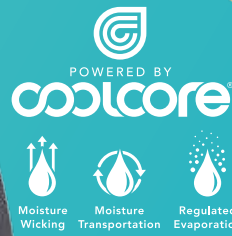

**TENACITY HELMET**

- Injection-molded plastic
- 1450 grams
- 14 intake and 8 exhaust vents for airflow
- DOT and ECE Certified
- » 2868624 • PINK XS-2XL • \$109<sup>99</sup>

**COOLING SHIRTS**

- 100% Poly, chemical free patented fabric from CoolCore®
- Moisture wicking to keep you dry
- Moisture transportation to keep you cool
- UPF 45+
- » MEN'S • 2868753 GRAY/ORANGE • S-3XL \$44<sup>99</sup>
- » WOMEN'S • 2868755 GRAY/PINK • S-3XL \$44<sup>99</sup>

**509° KINGPIN GOGGLE**

- Quick-change lens technology
- Contoured triple layer foam
- Premium anti-fog & anti-scratch coatings
- » 2868668 • ORANGE ONE SIZE • \$54<sup>99</sup>

**509° ALTITUDE CARBON HELMET**

- Carbon fiber shell
- 1100 grams
- Fidlock magnet closure
- 8 intake/exhaust vents for airflow
- DOT and ECE2205 Certified
- » 2867814 • BLACK MATTE S-4XL • \$399<sup>99</sup>

**MEN'S SOFTSHELL JACKET**

- Lined with 280 grams of fleece for warmth
- Removable hood
- Pit zips for venting
- » 2868514 • BLACK/ORANGE S-3XL • \$129<sup>99</sup>

STAY WARM

**509° ALTITUDE HELMET**

- Thermo Poly alloy shell
- 1260 grams
- 8 intake/exhaust vents for airflow
- DOT and ECE2205 Certified
- » 2868539 • LIME S-4XL • \$229<sup>99</sup>

**ORV RIDING JERSEY**

- 100% Poly
- Side mesh panels for venting
- » 2868711 • BLUE/LIME S-3XL • \$29<sup>99</sup>

**ORV RIDING GLOVES**

- Lycra panels provide flexibility in grip
- Soft flex graphics on knuckles for protection
- Lightly padded palm for comfort
- Machine washable
- » 2868712 • BLUE/LIME S-3XL • \$24<sup>99</sup>



**FORCE HELMET**

- Injection molded plastic
- 1380 grams
- 11 intake and 4 exhaust vents for airflow
- DOT Certified
- » 2868839 • BLUE XS-2XL • \$149<sup>99</sup>

**MID LAYERS**

- Flexible pill resistant poly fleece
- Ideal for layering or on it's own
- » WOMEN'S • 2868516 BLACK • S-3XL • \$74<sup>99</sup>
- » MEN'S • 2868512 BLACK • S-3XL • \$74<sup>99</sup>



KEEP YOUR COOL





**CAMO TRUCKER CAP**

» 2868750 • CAMO • ONE SIZE • \$24<sup>99</sup>

**HUNTER HOODIE**

» MEN'S • 2868716 • OLIVE HEATHER S-3XL • \$49<sup>99</sup>

» WOMEN'S • 2868721 [NOT SHOWN] OLIVE HEATHER • S-3XL • \$49<sup>99</sup>

**CAMO HOODIE**

» WOMEN'S • 2867898 • CAMO S-3XL • \$54<sup>99</sup>

» MEN'S • 2867879 [NOT SHOWN] CAMO • S-3XL • \$54<sup>99</sup>



**'MERICA RETRO CAP**

» 2867757 • BLUE/RED • ONE SIZE • \$24<sup>99</sup>

**MEN'S RETRO TEE**

» 2868571 • GRAY • S-3XL • \$39<sup>99</sup>

**WOMEN'S RETRO CAP**

» 2868617 • GRAY • ONE SIZE • \$24<sup>99</sup>

**WOMEN'S 3/4 BASEBALL TEE**

» 2868584 • GRAY/PINK • S-3XL • \$34<sup>99</sup>



**MEN'S RETRO LOGO HOODIE**

» 2868577 • GRAY • S-3XL • \$54<sup>99</sup>



**MEN'S ROSEAU HOODIE**

» 2868576 • OLIVE S-3XL • \$54<sup>99</sup>

**WOMEN'S RETRO HOODIE**

» 2868592 • BERRY S-3XL • \$49<sup>99</sup>



**WOMEN'S ASYMMETRICAL HOODIE**

» 2868596 • BERRY S-3XL • \$54<sup>99</sup>

**WOMEN'S V-NECK SCRIPT TEE**

» 2868588 • GRAY S-3XL • \$19<sup>99</sup>



**HEX CAP**

» 2867766 • BLACK • ONE SIZE • \$24<sup>99</sup>

**MEN'S EST TEE**

» 2868570 • BLACK • S-3XL • \$19<sup>99</sup>

**MEN'S HEX TEE**

» 2868568 • NAVY • S-3XL • \$19<sup>99</sup>

**WOMEN'S SCRIPT CREW SWEATSHIRT**

» 2868603 • CHARCOAL • S-2XL • \$49<sup>99</sup>



**WOMEN'S FULL ZIP RETRO HOODIE**

» 2868595 • CHARCOAL HEATHER S-3XL • \$54<sup>99</sup>



**REVERSIBLE CAMO BEANIE**

» 2867756 • ORANGE/CAMO ONE SIZE • \$19<sup>99</sup>

**MEN'S CAMO TEE**

» 2868757 • CAMO S-3XL • \$29<sup>99</sup>

**MEN'S TEXTILE RIDING JACKET**

» 2867875 • COFFEE S-3XL • \$149<sup>99</sup>



**CAMO WATER BOTTLE**

» 2867962 • \$19<sup>99</sup>

**CAMO COFFEE TRAVEL MUG**

» 2867961 • \$24<sup>99</sup>

**CAMO BOTTLE KOOZIE**

» 2867964 • \$9<sup>99</sup>

**CAMO CAN KOOZIE**

» 2867963 • \$5<sup>99</sup>

**CAMO STEERING WHEEL COVER**

» 2868663 • \$14<sup>99</sup>

**CAMO BOTTLE OPENER [NOT SHOWN]**

» 2867965 • \$9<sup>99</sup>



**RETRO CLOCK**

» 2868662 • \$29<sup>99</sup>

**PINT GLASS SET OF 2**

» 2866265 • \$14<sup>99</sup>

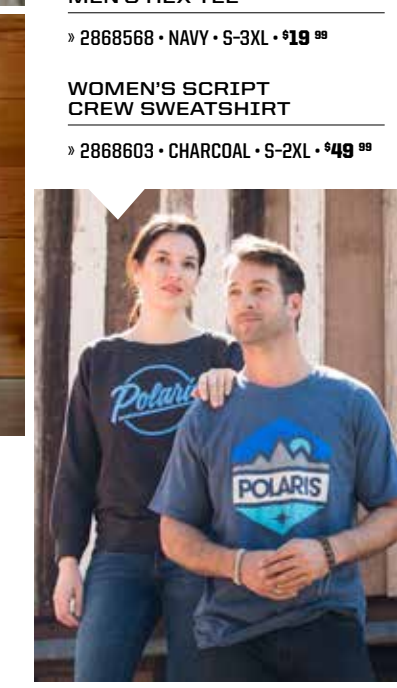

**WOMEN'S ROSEAU TEE**

» 2868586 • BLACK • S-3XL • \$19<sup>99</sup>

**MEN'S MFG CO TEE**

» 2868776 • BLACK • S-3XL • \$19<sup>99</sup>